

CONTENTS

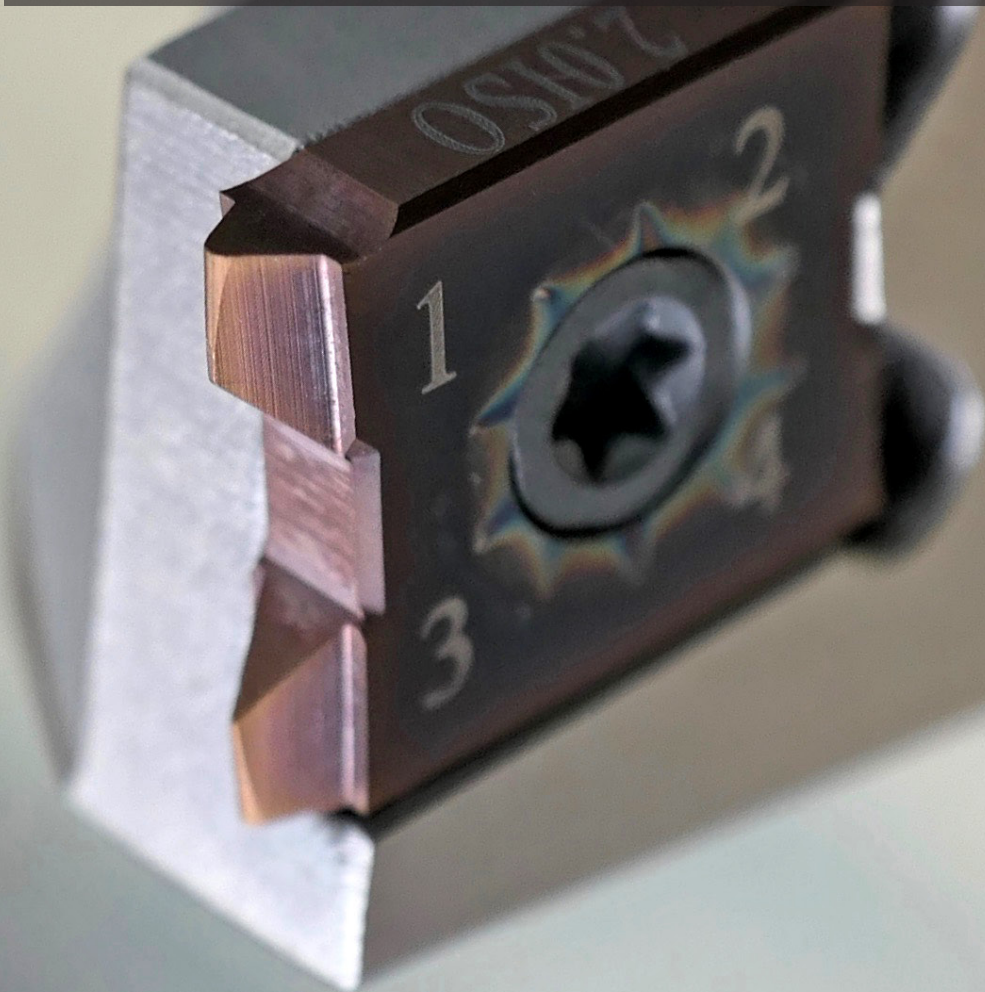

THREAD MILLING TOOLS	3
THREAD TURNING TOOLS	31
SOLID CARBIDE END MILLS	66
SOLID CARBIDE DRILLS	115
CARBIDE RODS	127



ThreadBurr

The Master of Threading

Threading and deburring
in one operation

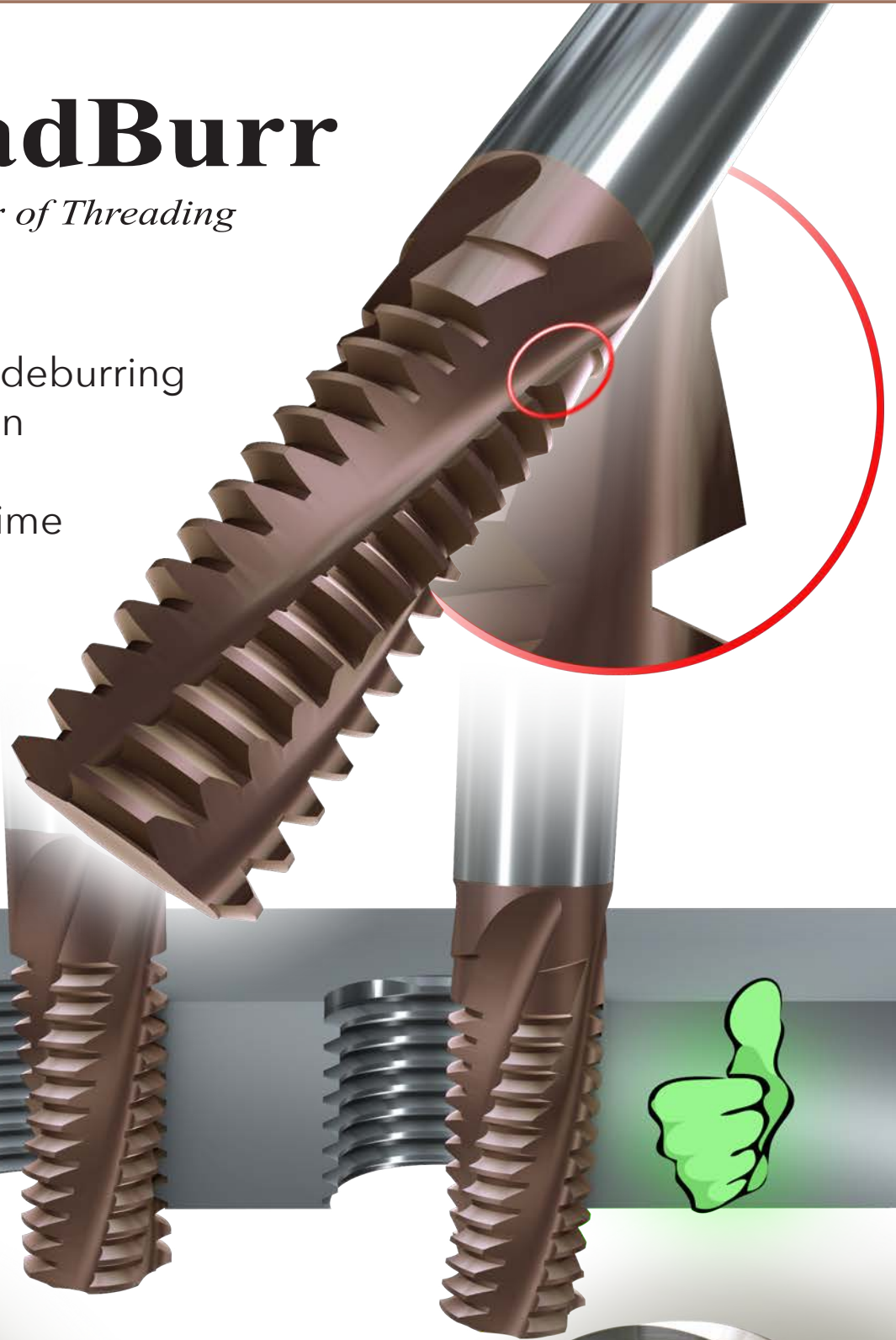

No additional time
for deburring



THREAD MILLING

CONTENTS

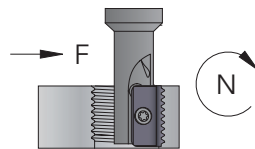
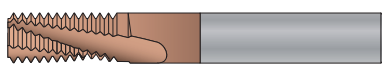
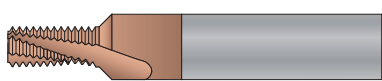
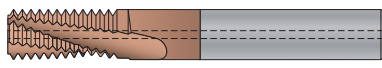
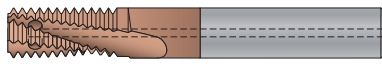
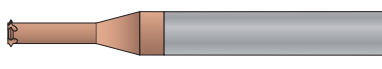
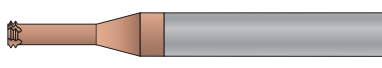

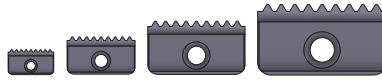
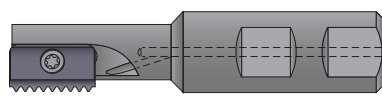
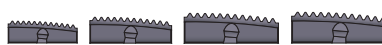
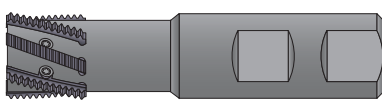
Technical Information	4	
Solid Carbide Thread Mills, ThreadBurr	12	
with Chamfer	17	
with Internal Coolant	18	
with Internal Radial Coolant	19	
with One Tooth	20	
with Two Teeth	21	
Tapered End Mills for NPT/NPTF/BSPT	16	
Straight Fluted Inserts	22	
Thread Milling Cutters	24	
Spiral Fluted Inserts	26	
Thread Milling Cutters	28	

ThreadBurr

The advantage with ThreadBurr is that you can thread and deburr in one operation. No additional time for deburring and countersink is needed. The deburring operation is made automatically when thread milling, which gives you the deburring without any extra costs.

There is no disadvantage to use the ThreadBurr, even if you don't use the deburring function. ThreadBurr is standard on all thread mills from SmiCut.

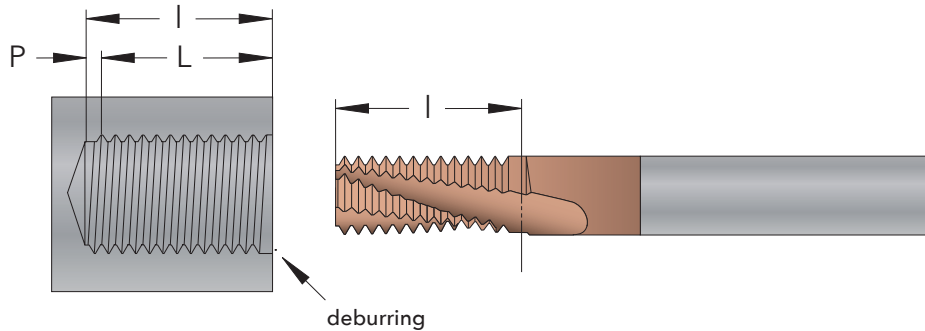

To get a nice entry and a burr free thread you need to start out with going to full depth (l) in to the hole before starting the threading operation. The thread length (L) will be the cutting length (l) minus one pitch (P).

Double ThreadBurr

It is possible to get the thread deburred on both sides. For this operation you need to use a special tool as thread length depends on the thickness of the material. Have in mind the following when you order a tool for deburring on both sides.

- The cutting length (l) should be equivalent to the thickness of the material.

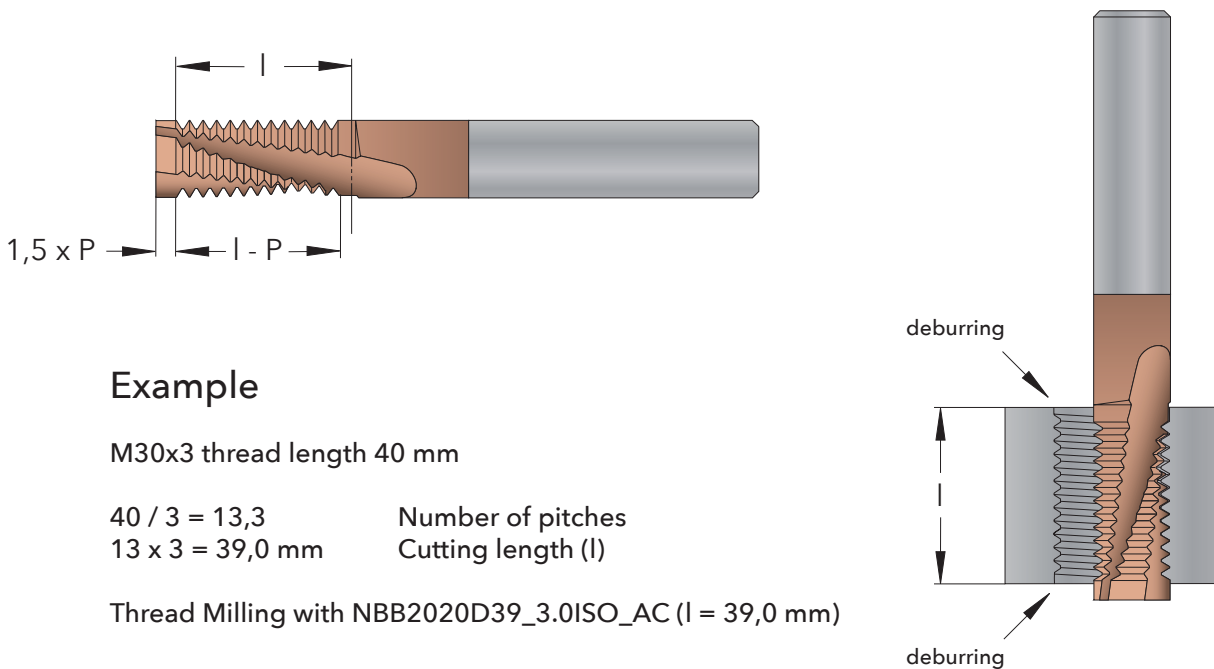

Example

M30x3 thread length 40 mm

$40 / 3 = 13,3$ Number of pitches
 $13 \times 3 = 39,0$ mm Cutting length (l)

Thread Milling with NBB2020D39_3.0ISO_AC (l = 39,0 mm)

ThreadBurr

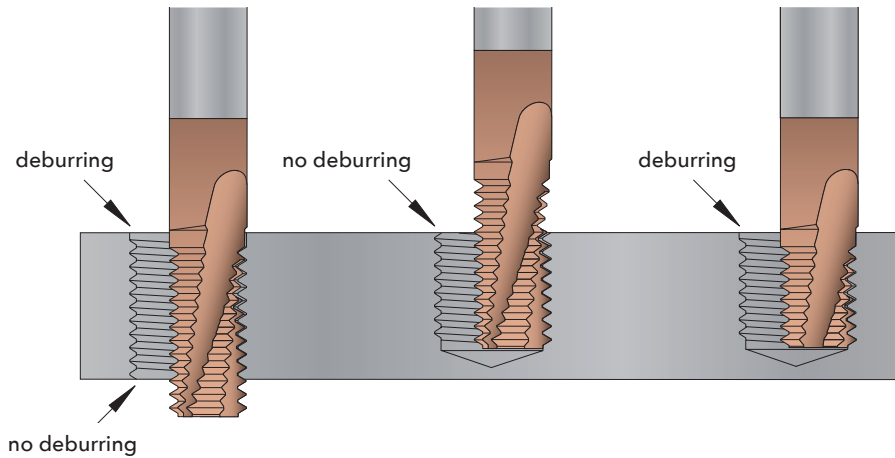

Through holes

You can always use a standard tool for through holes. Please take in mind you should use a tool as short as possible to get best stability and economy.

Blind Holes

With blind holes it is important to have the correct cutting length (l) on the tool to get the thread deburred. Normally you will find a suitable standard tool. If not, we will cut the tool to the correct length with extremely short delivery time and at a reasonable price. Have in mind the following when you order a tool for blind holes.

- The cutting length (l) should be required thread length (L) plus one pitch (P).
- The distance to cut off (c) has to be dividable by the pitch (P).

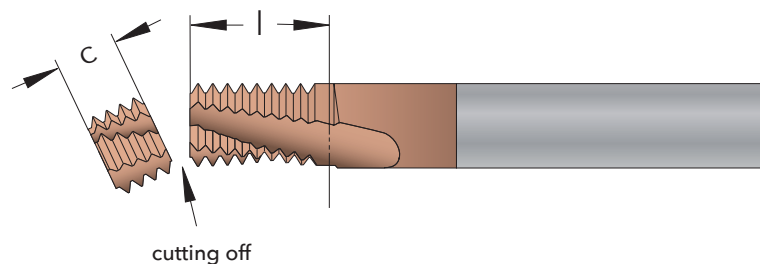

Example

M16x1,5 thread length 24 mm
Thread Milling with NB1212D29_1.5ISO_AC (L = 29,25 mm)

$24 + 1,5 = 25,5$ mm	Required cutting length (l)
$29,25 - 25,5 = 3,75$ mm	Maximum cutting off
$3,75 / 1,5 = 2,5$	Number of pitches to cut off
$2 \times 1,5 = 3,0$ mm	Distance to cut off (c)
$29,25 - 3,0 = 26,25$ mm	Cutting length (l) after cutting off
$26,25 - 1,5 = 24,75$ mm	Thread length (L) after cutting off

You only need to cut off the tool when you want to use the deburring function on blind holes and if there is no standard tool with suitable cutting length.

Advantages

■ 1) A secure machining operation

Minimal risk for machining stops as the cutting forces are low and the chips are short. Should there be an accident, the work piece will not be destroyed, as the tool will not be caught since the diameter of the thread mill is less than the thread.

■ 2) Threading in difficult machined materials

The excellent cutting conditions makes it possible to thread mill materials such as hardened steel up to HRC 65, Titanium and other difficult machined materials.

■ 3) Higher thread quality

The cutting conditions are extremely good when you are thread milling. The result of the thread is a higher quality of surface finish, tolerance, angle, etc. compared with other threading methods.

■ 4) Flexible tool

Same cutter can be used for right hand and left hand thread. Threads with different diameters can be made with the same tool as long as the pitch is the same. The same thread mill can be used for blind holes and through holes. W, BSPT, PG, NPT, NPTF and NPSF are thread profiles where you can use the same tool for external and internal thread.

■ 5) Threading in blind holes

When thread milling you will get a complete thread profile to the bottom of the hole. When tapping it's necessary to drill much deeper as it's not until the third thread the tap will make a complete thread profile. Sometimes you are able to change the construction as you don't have to take the deep hole into consideration.

■ 6) Less wear on the machine spindle

Thread milling will give you longer life to the machine spindle compared with tapping as the rotation on the spindle doesn't need to be stopped and reversed for every thread.

■ 7) Energy-saving production

Low energy consumption as the machine spindle doesn't need to be stopped and started after each thread.

■ 8) Thread Milling in a lathe with live tools

Reduced machining time compared with thread turning. Excellent chip control.

■ 9) Threading without burrs

The thread entrance will be burr free when using ThreadBurr. Threading and deburring in one operation. No additional time for deburring.

■ 10) Shorter machining time

The machining time will be short as you don't need to chamfer the thread while using ThreadBurr. Big diameters, fine pitches and long holes saves the most time compared with thread tapping.

■ 11) Correct Thread Diameter right away

The Pitch diameter has been optically measured on thread mills from SmiCut and the theoretical external diameter has been individually laser marked on each cutter so you will get a correct thread straight away. When the tool starts to wear it's possible to make adjustments in the CNC-program.

Deburring of the thread

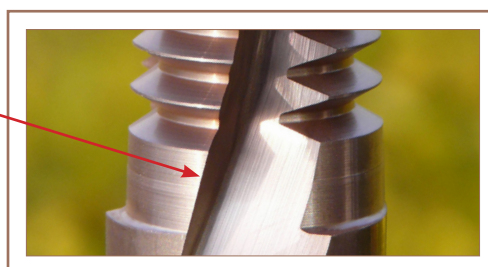

Correct Diameter

How to choose correct Thread Mill Diameter

When thread milling, the diameter of the tool has to be smaller than the thread diameter. The reason for this is that the thread has a helix angle, but the tool is straight. If the tool is too big there will be a deviation on the thread profile. The size of this deviation depends on several parameters.

- 1) Thread diameter
- 2) Cutter diameter
- 3) Profile angle
- 4) Pitch

Big cutter diameter compared with thread diameter, small profile angle and big pitch. These are parameters that gives bigger deviation.



There are three alternatives too choose correct thread mill diameter.

- 1) SmiCut Catalogue
- 2) SmiCut Online Store, www.smicutstore.se (see page 8)
- 3) SmiProg Software, www.smicut.se (see page 9)

How to get correct Thread Diameter

The pitch diameter has become optically measured on thread mills from SmiCut and the theoretical external diameter has been individually laser marked on each cutter. This diameter is what you should use in your program to get a correct diameter on your thread.

For coarse threads you are normally in the middle of the tolerance if you use the laser marked value.

Fine threads may be a little bit tight as you get a very small thread profile deviation on these threads (see above). If this is the case you can mill again after adjusting the diameter in your program.

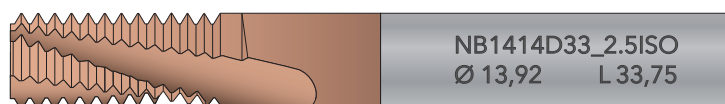

How to get a burr free Thread

Thread Mills from SmiCut (ThreadBurr) will give you a nice entry and a burr free thread. The cutting length is laser marked on the tool and you can find it as well in the catalogue. This is the distance you should go in to the hole from the surface to get a perfect entry.

SmiCut Online Store will help you find suitable tools

If you need a Thread Mill for a specific thread and you need help to find the correct tool, just go to www.smicutstore.se and you will very quickly find suitable tools.

Example: M16 with thread length 32 mm

- 1) Choose THREAD MILLING Application on the left side
- 2) Choose M - Metric coarse
- 3) Choose M16
- 4) Choose what kind of tool you want, for example without coolant

Now you can see all solid carbide thread mills without coolant that are able to produce M16. From these ones you have to take a tool with a cutting length of at least 32 mm. You can see the cutting length on the part number (see next page for more information about "code key"). The most suitable tool is NB1212D35_2.0ISO_AC. If you want complete information about the dimensions press on the part number of the tool.

You are as well able to do this thread with a tool with a smaller diameter or longer thread length, but this result in longer machining time and/or not as good cutting conditions. Sometimes you choose this anyhow as you may already have the tool, the price is less or you want to have a tool that can make different sizes of threads.

To check machining time and cutting conditions for different tools, please use "SmiProg" (see next page).

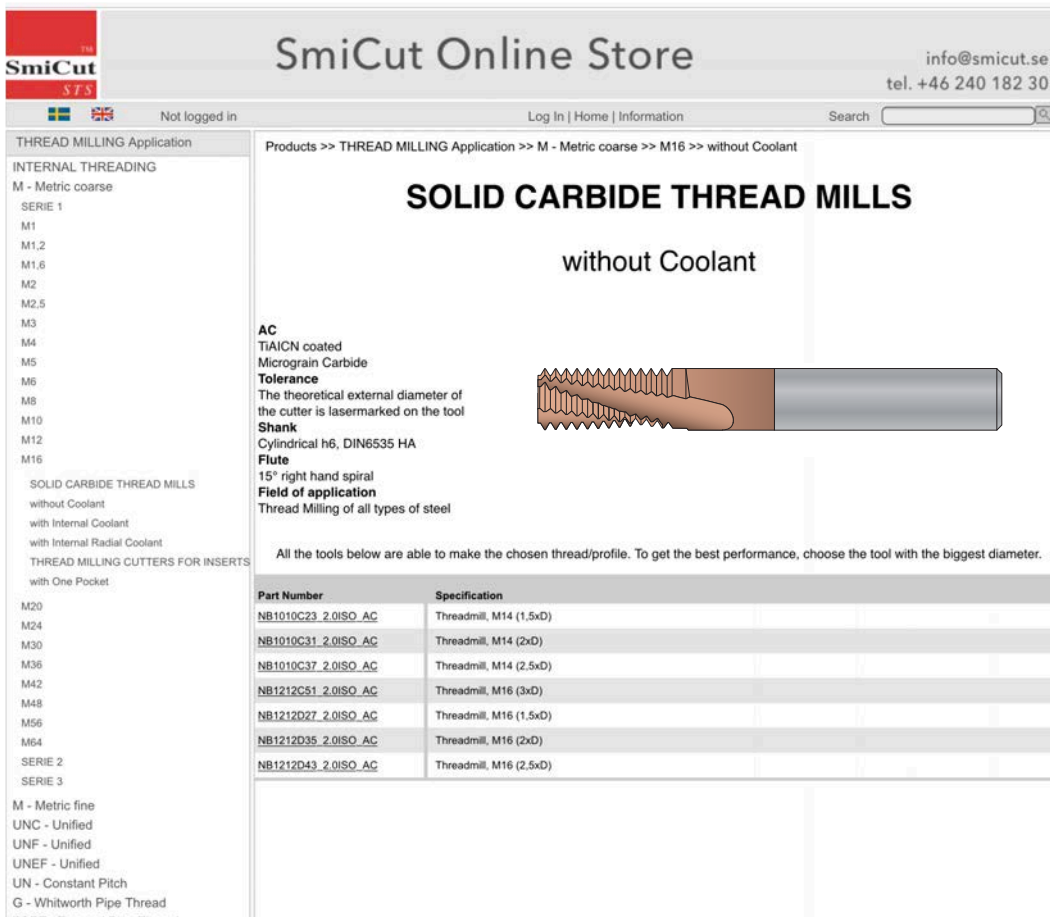

SmiCut Online Store info@smicut.se
tel. +46 240 182 30

Not logged in Log In | Home | Information Search

THREAD MILLING Application
INTERNAL THREADING
M - Metric coarse
SERIE 1
M1
M1.2
M1.6
M2
M2.5
M3
M4
M5
M6
M8
M10
M12
M16
SOLID CARBIDE THREAD MILLS
without Coolant
with Internal Coolant
with Internal Radial Coolant
THREAD MILLING CUTTERS FOR INSERTS
with One Pocket
M20
M24
M30
M36
M42
M48
M56
M64
SERIE 2
SERIE 3
M - Metric fine
UNC - Unified
UNF - Unified
UNEF - Unified
UN - Constant Pitch
G - Whitworth Pipe Thread
BPT - Thread Pipe Thread

Products >> THREAD MILLING Application >> M - Metric coarse >> M16 >> without Coolant

SOLID CARBIDE THREAD MILLS

without Coolant

AC
TiAlCN coated
Micrograin Carbide
Tolerance
The theoretical external diameter of the cutter is lasermarked on the tool
Shank
Cylindrical h6, DIN6535 HA
Flute
15° right hand spiral
Field of application
Thread Milling of all types of steel

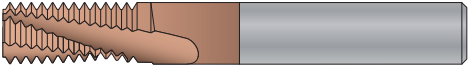

All the tools below are able to make the chosen thread/profile. To get the best performance, choose the tool with the biggest diameter.

Part Number	Specification
NB1010C23_2.0ISO_AC	Threadmill, M14 (1.5xD)
NB1010C31_2.0ISO_AC	Threadmill, M14 (2xD)
NB1010C37_2.0ISO_AC	Threadmill, M14 (2.5xD)
NB1212C51_2.0ISO_AC	Threadmill, M16 (3xD)
NB1212D27_2.0ISO_AC	Threadmill, M16 (1.5xD)
NB1212D35_2.0ISO_AC	Threadmill, M16 (2xD)
NB1212D43_2.0ISO_AC	Threadmill, M16 (2.5xD)

Software for Thread Milling

SmiProg makes it easy to Thread Mill

Specify control system, material, thread diameter, pitch and thread length. The program will recommend suitable tools. Choose one and you will receive suggested cutting data, time to mill the thread and CNC programming code. The software is made in excel and is less than 500kb even though it includes 22 different languages. You can download SmiProg free of charge at www.smicut.se

Choose among these languages

- Chinese (simp.)
- Chinese (trad.)
- Czech
- Danish
- Dutch
- English
- Estonian
- Euskera
- Finish
- French
- German
- Hungarian
- Italian
- Japanese
- Korean
- Norwegian
- Polish
- Portuguese
- Romanian
- Russian
- Spanish
- Swedish

Tutorial Video Series

Learn how to use SmiProg and our Thread Mills with video tutorials. Following videos are available. More parts will be uploaded in the future.

- Part 1: Introduction
- Part 2: The Basic Features
- Part 3: ThreadBurr & Correct Diameter

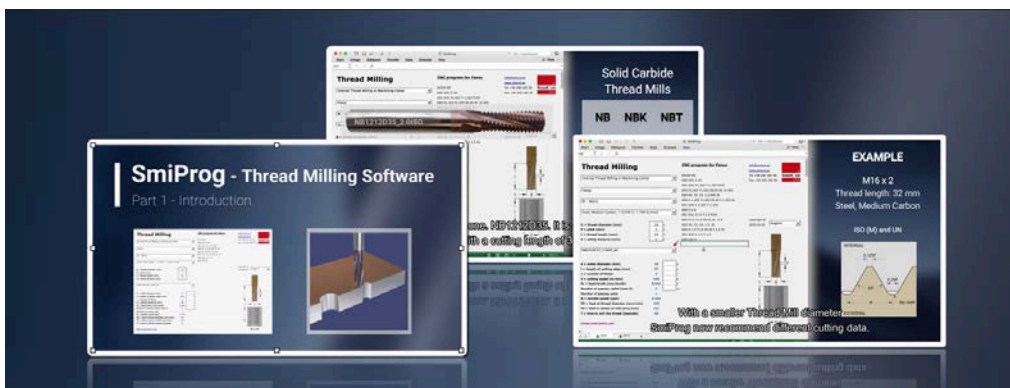

Code Key

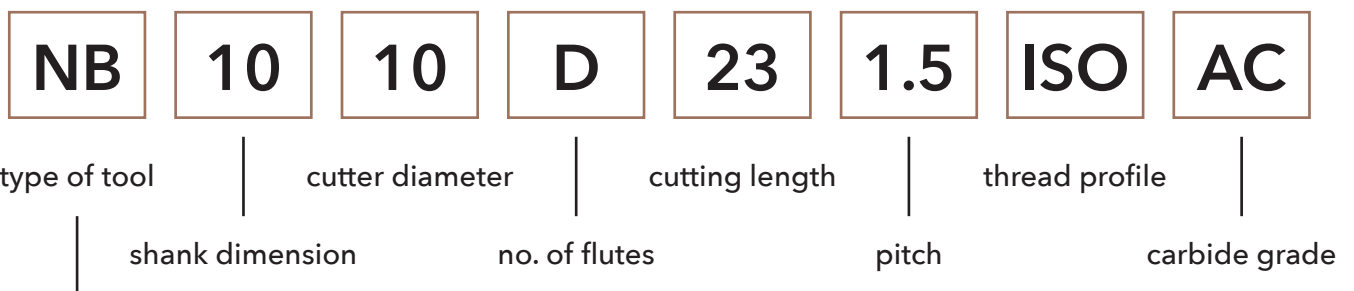

- N = internal threading
- E = external threading
- X = in- and external threading
- B = burring
- BB = burring on both sides
- F = chamfering
- S = with one tooth
- M = with two teeth
- K = internal coolant
- T = internal radial coolant

- C = three flute
- D = four flute
- E = five flute
- F = six flute

Cutting Speed (V_c) and Material Factor (F_m)

MATERIAL		Hardness HB	Tensile Strength N/mm ²	Cutting Speed (V_c) m/min	Material Factor (F_m)
Steel	Low carbon, C < 0,25%	< 120	< 400	150 - 200	1,2
	Medium carbon, C < 0,55%	< 200	< 700	120 - 170	1,1
	High carbon, C < 0,85%	< 250	< 850	110 - 150	1,0
	Low alloy	< 250	< 850	100 - 140	1,0
	High alloy	< 350	< 1200	70 - 110	0,9
	Hardened, HRC < 45			60 - 100	0,8
	Hardened, HRC < 55			30 - 60	0,7
	Hardened, HRC < 65			20 - 40	0,6
Cast iron	Lamellar graphite	< 150	< 500	130 - 180	1,2
	Lamellar graphite	< 300	< 1000	100 - 150	1,1
	Nodular graphite, malleable	< 200	< 700	100 - 150	1,0
	Nodular graphite, malleable	< 300	< 1000	80 - 120	0,9
Stainless steel	Free machining	< 250	< 850	130 - 180	1,0
	Austenitic	< 250	< 850	90 - 140	0,9
	Ferritic and austenitic	< 300	< 1000	80 - 120	0,8
Titanium	Unalloyed	< 200	< 700	60 - 80	0,8
	Alloyed	< 270	< 900	50 - 70	0,7
	Alloyed	< 350	< 1250	30 - 50	0,6
Nickel	Unalloyed	< 150	< 500	80 - 120	0,8
	Alloyed	< 270	< 900	60 - 80	0,7
	Alloyed	< 350	< 1250	50 - 70	0,6
Copper	Unalloyed	< 100	< 350	150 - 250	1,0
	Brass, bronze	< 200	< 700	130 - 180	1,0
	High strength bronze	< 470	< 1500	60 - 80	0,8
Aluminium	Unalloyed	< 100	< 350	500 - 900	1,4
	Alloyed, Si < 0.5%	< 150	< 500	400 - 800	1,3
	Alloyed, Si < 10%	< 120	< 400	300 - 500	1,2
	Alloyed, Si > 10%	< 120	< 400	200 - 400	1,1
Inconel	718	< 370		50 - 70	0,6
Graphite				300 - 500	1,0

Engagement Factor (F_e)

	B/d = 0,05	B/d = 0,06	B/d = 0,07	B/d = 0,08	B/d = 0,09	B/d = 0,10	B/d = 0,12	B/d = 0,14	B/d = 0,16
L/d = 1,0	1,75	1,59	1,45	1,31	1,20	1,09	0,99	0,90	0,82
L/d = 1,25	1,52	1,38	1,25	1,14	1,04	0,94	0,86	0,78	0,70
L/d = 1,5	1,31	1,20	1,09	0,99	0,90	0,82	0,74	0,67	0,61
L/d = 1,75	1,20	1,09	0,99	0,90	0,82	0,74	0,67	0,61	0,56
L/d = 2,0	1,09	0,99	0,90	0,82	0,74	0,67	0,61	0,56	0,51
L/d = 2,25	0,99	0,90	0,82	0,74	0,67	0,61	0,56	0,51	0,46
L/d = 2,5	0,90	0,82	0,74	0,67	0,61	0,56	0,51	0,46	0,42
L/d = 3,0	0,78	0,70	0,64	0,58	0,53	0,48	0,44	0,40	0,36
L/d = 3,5	0,67	0,61	0,56	0,51	0,46	0,42	0,38	0,35	0,31
L/d = 4,0	0,61	0,56	0,51	0,46	0,42	0,38	0,35	0,31	0,29

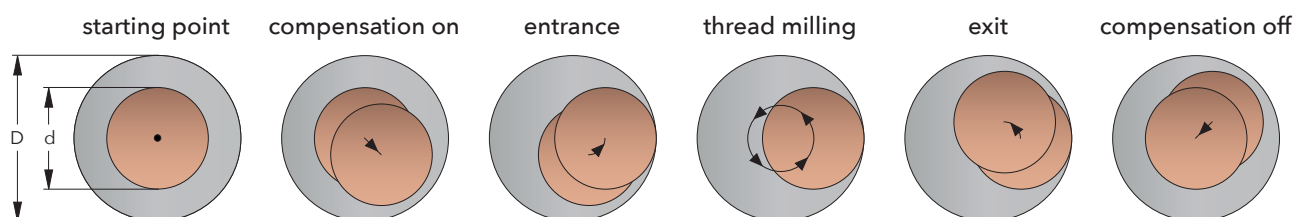

Diameter Factor (F_d)

d	Diameter Factor (F_d)
1,5	0,010
2,0	0,011
3,0	0,015
4,0	0,019
5,0	0,024
6,0	0,028
8,0	0,036
10,0	0,044
12,0	0,052
14,0	0,060
16,0	0,067
18,0	0,075
20,0	0,082
25,0	0,101
32,0	0,126
40,0	0,156

Example

M24x3,0 thread length 36 mm
 Carbon Steel, up to 400 N/mm²
 Thread Milling with NB1616C40_3.0ISO_AC
 $B = 0,54 \times 3 = 1,62 \text{ mm}$
 $B/d = 1,62/16 = 0,10$
 $L/d = 36/16 = 2,25$
 $F_z = 1,2 \times 0,61 \times 0,067 = 0,049$
 $n = (160 \times 1000) / (\pi \times 16) = 3183 \text{ rpm}$
 $V_{fD} = 0,049 \times 3 \times 3183 = 468 \text{ mm/min}$
 $V_{fd} = 468 \times (24-16) / 24 = 156 \text{ mm/min}$
 $T = (278 \times 24) / 468 = 14 \text{ seconds}$

$$B = 0,54 \times P$$

$$F_z = F_m \times F_e \times F_d$$

$$n = \frac{V_c \times 1000}{\pi \times d}$$

$$V_{fD} = F_z \times z \times n$$

$$V_{fd} = V_{fD} \times \frac{(D - d)}{D}$$

$$T = 278 \times \frac{D}{V_{fd}}$$

D = thread diameter (mm)

L = thread length (mm)

d = cutter diameter (mm)

B = depth of profile (mm)

P = pitch (mm)

z = no. of flutes

F_z = feed / flute (mm/flute)

n = spindle speed (rpm)

V_c = cutting speed (m/min)

V_{fD} = feed at thread diameter \varnothing (mm/min)

V_{fd} = feed at center of mill (mm/min)

T = time to mill the thread (seconds)

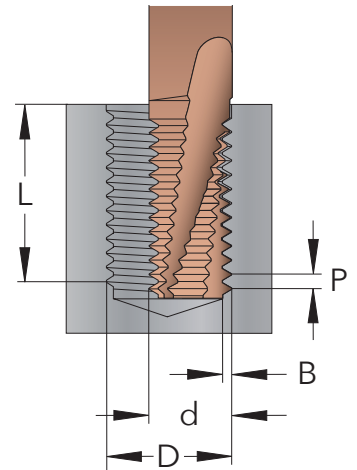

Carbide Grades

AC

Micrograin Carbide with TiAlCN coating.
 Allround Grade with low friction.
 Use cutting data according to the tables.

FC

Micrograin Carbide with TiAlN coating.
 Allround Grade with high heat resistance.
 Use cutting data according to the tables.

ThreadBurr

AC
TiAlCN coated
Micrograin Carbide
Tolerance
The theoretical external diameter of the cutter is lasermarked on the tool.
Shank
Cylindrical h6, DIN6535 HA
Flute
15° right hand spiral
Field of application
Thread Milling of all types of steel

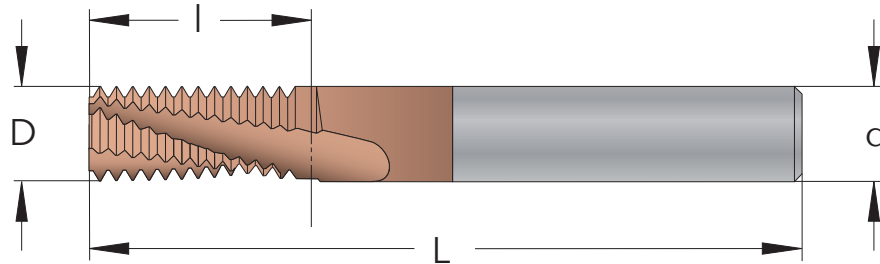

M

METRIC

Pitch mm	M coarse	M fine	INTERNAL Part Number	d mm	D mm	No. of Flutes	l mm	L mm
0,4	M2 (1,5xD)		NB04015C3_0.4ISO_AC	4	1,5	3	3,4	50
0,4	M2 (2xD)		NB04015C4_0.4ISO_AC	4	1,5	3	4,6	50
0,45	M2,2 (1,5xD)		NB04016C3_0.45ISO_AC	4	1,65	3	3,82	50
0,45	M2,2 (2xD)		NB04016C5_0.45ISO_AC	4	1,65	3	5,17	50
0,45	M2,5 (1,5xD)		NB04019C4_0.45ISO_AC	4	1,9	3	4,27	50
0,45	M2,5 (2xD)		NB04019C5_0.45ISO_AC	4	1,9	3	5,62	50
0,5	M3 (1,5xD)	≥ M3,5	NB04023C5_0.5ISO_AC	4	2,3	3	5,25	50
0,5	M3 (2xD)	≥ M3,5	NB04023C6_0.5ISO_AC	4	2,3	3	6,75	50
0,5	M3 (2,5xD)	≥ M3,5	NB04023C8_0.5ISO_AC	4	2,3	3	8,25	50
0,5	M3 (1,5xD)	≥ M3,5	NB06023C5_0.5ISO_AC	6	2,3	3	5,25	63
0,5	M3 (2xD)	≥ M3,5	NB06023C6_0.5ISO_AC	6	2,3	3	6,75	63
0,5	M3 (2,5xD)	≥ M3,5	NB06023C8_0.5ISO_AC	6	2,3	3	8,25	63
0,5		≥ M5	NB04038C10_0.5ISO_AC	4	3,8	3	10,75	50
0,5		≥ M5	NB06038C10_0.5ISO_AC	6	3,8	3	10,75	63
0,6	M3,5 (1,5xD)		NB04026C6_0.6ISO_AC	4	2,6	3	6,3	50
0,6	M3,5 (2xD)		NB04026C8_0.6ISO_AC	4	2,6	3	8,1	50
0,7	M4 (1,5xD)		NB0403C7_0.7ISO_AC	4	3	3	7,35	50
0,7	M4 (2xD)		NB0403C8_0.7ISO_AC	4	3	3	8,75	50
0,7	M4 (2,5xD)		NB0403C10_0.7ISO_AC	4	3	3	10,85	50
0,7	M4 (1,5xD)		NB0603C7_0.7ISO_AC	6	3	3	7,35	63
0,7	M4 (2xD)		NB0603C8_0.7ISO_AC	6	3	3	8,75	63
0,7	M4 (2,5xD)		NB0603C10_0.7ISO_AC	6	3	3	10,85	63
0,75	M4,5 (1,5xD)	≥ M5	NB04034C7_0.75ISO_AC	4	3,4	3	7,87	50
0,75	M4,5 (2xD)	≥ M5	NB04034C10_0.75ISO_AC	4	3,4	3	10,12	50
0,75		≥ M6	NB06045C10_0.75ISO_AC	6	4,5	3	10,87	63
0,75		≥ M6	NB06045C16_0.75ISO_AC	6	4,5	3	16,87	63
0,8	M5 (1,5xD)		NB04038C8_0.8ISO_AC	4	3,8	3	8,4	50
0,8	M5 (2xD)		NB04038C10_0.8ISO_AC	4	3,8	3	10,8	50
0,8	M5 (2,5xD)		NB04038C13_0.8ISO_AC	4	3,8	3	13,2	50
0,8	M5 (1,5xD)		NB06038C8_0.8ISO_AC	6	3,8	3	8,4	63
0,8	M5 (2xD)		NB06038C10_0.8ISO_AC	6	3,8	3	10,8	63
0,8	M5 (2,5xD)		NB06038C13_0.8ISO_AC	6	3,8	3	13,2	63
1	M6 (1,5xD)	≥ M8	NB06045C10_1.0ISO_AC	6	4,5	3	10,5	63
1	M6 (2xD)	≥ M8	NB06045C13_1.0ISO_AC	6	4,5	3	13,5	63
1	M6 (2,5xD)	≥ M8	NB06045C16_1.0ISO_AC	6	4,5	3	16,5	63
1	M6 (3xD)	≥ M8	NB06045C19_1.0ISO_AC	6	4,5	3	19,5	63
1		≥ M8	NB0606C10_1.0ISO_AC	6	6	3	10,5	63
1		≥ M8	NB0606C13_1.0ISO_AC	6	6	3	13,5	63
1		≥ M10	NB0808D10_1.0ISO_AC	8	8	4	10,5	63
1		≥ M10	NB0808D13_1.0ISO_AC	8	8	4	13,5	63
1		≥ M10	NB0808D17_1.0ISO_AC	8	8	4	17,5	63
1		≥ M12	NB1010E14_1.0ISO_AC	10	10	5	14,5	76
1		≥ M12	NB1010E19_1.0ISO_AC	10	10	5	19,5	76
1		≥ M14	NB1212F15_1.0ISO_AC	12	12	6	15,5	83
1		≥ M14	NB1212F21_1.0ISO_AC	12	12	6	21,5	83
1,25	M8 (1,5xD)	≥ M10	NB0606C14_1.25ISO_AC	6	6	3	14,37	63

continue

M

METRIC

Pitch mm	M coarse	M fine	INTERNAL Part Number	d mm	D mm	No. of Flutes	l mm	L mm
1,25	M8 (2xD)	≥ M10	NB0606C18_1.25ISO_AC	6	6	3	18,12	63
1,25	M8 (2,5xD)	≥ M10	NB0606C21_1.25ISO_AC	6	6	3	21,87	63
1,25	M8 (3xD)	≥ M10	NB0606C25_1.25ISO_AC	6	6	3	25,62	76
1,5	M10 (1,5xD)	≥ M12	NB08075C17_1.5ISO_AC	8	7,5	3	17,25	63
1,5	M10 (2xD)	≥ M12	NB08075C21_1.5ISO_AC	8	7,5	3	21,75	76
1,5	M10 (2,5xD)	≥ M12	NB08075C27_1.5ISO_AC	8	7,5	3	27,75	76
1,5	M10 (3xD)	≥ M12	NB08075C32_1.5ISO_AC	8	7,5	3	32,25	76
1,5		≥ M14	NB1010D17_1.5ISO_AC	10	10	4	17,25	76
1,5		≥ M14	NB1010D23_1.5ISO_AC	10	10	4	23,25	76
1,5		≥ M16	NB1212E15_1.5ISO_AC	12	12	5	15,75	83
1,5		≥ M16	NB1212E21_1.5ISO_AC	12	12	5	21,75	83
1,5		≥ M16	NB1212E29_1.5ISO_AC	12	12	5	29,25	83
1,5		≥ M20	NB1616F18_1.5ISO_AC	16	16	6	18,75	89
1,5		≥ M20	NB1616F26_1.5ISO_AC	16	16	6	26,25	89
1,5		≥ M20	NB1616F35_1.5ISO_AC	16	16	6	35,25	100
1,75	M12 (1,5xD)		NB0808C20_1.75ISO_AC	8	8	3	20,12	76
1,75	M12 (2xD)		NB0808C27_1.75ISO_AC	8	8	3	27,12	76
1,75	M12 (1,5xD)		NB1009C20_1.75ISO_AC	10	9	3	20,12	76
1,75	M12 (2xD)		NB1009C27_1.75ISO_AC	10	9	3	27,12	76
1,75	M12 (2,5xD)		NB1009C32_1.75ISO_AC	10	9	3	32,37	100
1,75	M12 (3xD)		NB1009C37_1.75ISO_AC	10	9	3	37,62	100
2	M14 (1,5xD)	≥ M18	NB1010C23_2.0ISO_AC	10	10	3	23	76
2	M14 (2xD)	≥ M18	NB1010C31_2.0ISO_AC	10	10	3	31	100
2	M14 (2,5xD)	≥ M18	NB1010C37_2.0ISO_AC	10	10	3	37	100
2	M16 (1,5xD)	≥ M18	NB1212D27_2.0ISO_AC	12	12	4	27	83
2	M16 (2xD)	≥ M18	NB1212D35_2.0ISO_AC	12	12	4	35	100
2	M16 (2,5xD)	≥ M18	NB1212D43_2.0ISO_AC	12	12	4	43	100
2	M16 (3xD)	≥ M18	NB1212C51_2.0ISO_AC	12	12	3	51	100
2		≥ M20	NB1616E29_2.0ISO_AC	16	16	5	29	89
2		≥ M20	NB1616E39_2.0ISO_AC	16	16	5	39	100
2		≥ M24	NB2020F43_2.0ISO_AC	20	20	6	43	100
2		≥ M24	NB2020F57_2.0ISO_AC	20	20	6	57	120
2,5	M18 (1,5xD)		NB1212C31_2.5ISO_AC	12	12	3	31,25	100
2,5	M18 (2xD)		NB1212C38_2.5ISO_AC	12	12	3	38,75	100
2,5	M18 (2,5xD)		NB1212C48_2.5ISO_AC	12	12	3	48,75	100
2,5	M20 (1,5xD)		NB1414D33_2.5ISO_AC	14	14	4	33,75	89
2,5	M20 (2xD)		NB1414D43_2.5ISO_AC	14	14	4	43,75	100
2,5	M20 (2,5xD)		NB1615D53_2.5ISO_AC	16	15	4	53,75	120
2,5	M20 (3xD)		NB1615C63_2.5ISO_AC	16	15	3	63,75	120
3	M24 (1,5xD)	≥ M30	NB1616C40_3.0ISO_AC	16	16	3	40,5	100
3	M24 (2xD)	≥ M30	NB1616C52_3.0ISO_AC	16	16	3	52,5	120
3	M24 (2,5xD)	≥ M30	NB1818C64_3.0ISO_AC	18	18	3	64,5	130
3		≥ M30	NB2020D46_3.0ISO_AC	20	20	4	46,5	120
3		≥ M30	NB2020D61_3.0ISO_AC	20	20	4	61,5	150
3,5	M30 (1,5xD)		NB2020C50_3.5ISO_AC	20	20	3	50,75	120
3,5	M30 (2xD)		NB2020C64_3.5ISO_AC	20	20	3	64,75	150
3,5	M30 (2,5xD)		NB2020C78_3.5ISO_AC	20	20	3	78,75	150
4	M36 (1,5xD)	≥ M42	NB2020C58_4.0ISO_AC	20	20	3	58	150

M

METRIC (external)

Pitch mm	EXTERNAL Part Number	d mm	D mm	No. of Flutes	l mm	L mm
1,0	EB1010E21_1.0ISO_AC	10	10	5	21,5	76
1,5	EB1212E26_1.5ISO_AC	12	12	5	26,25	83
2,0	EB1616E35_2.0ISO_AC	16	16	5	35	100

UN

UNIFIED

Pitch TPI	UNC	UNF	INTERNAL Part Number	d mm	D mm	No. of Flutes	l mm	L mm
64		No. 2 (1,5xD)	NB04017C3_64UN_AC	4	1,7	3	3,77	50
64		No. 2 (2xD)	NB04017C5_64UN_AC	4	1,7	3	4,96	50
56	No. 2 (1,5xD)		NB04016C3_56UN_AC	4	1,6	3	3,86	50
56	No. 2 (2xD)		NB04016C5_56UN_AC	4	1,6	3	5,22	50
56		No. 3 (1,5xD)	NB04019C4_56UN_AC	4	1,9	3	4,31	50
56		No. 3 (2xD)	NB04019C5_56UN_AC	4	1,9	3	5,67	50
48	No. 3 (1,5xD)		NB04019C4_48UN_AC	4	1,9	3	4,5	50
48	No. 3 (2xD)		NB04019C5_48UN_AC	4	1,9	3	5,56	50
48		No. 4 (1,5xD)	NB04021C5_48UN_AC	4	2,1	3	5,03	50
48		No. 4 (2xD)	NB04021C6_48UN_AC	4	2,1	3	6,61	50
44		No.5 (1,5xD)	NB04024C5_44UN_AC	4	2,4	3	5,48	50
44		No.5 (2xD)	NB04024C7_44UN_AC	4	2,4	3	7,22	50
40	No. 4 (1,5xD)		NB04021C5_40UN_AC	4	2,1	3	5,4	50
40	No. 4 (2xD)		NB04021C6_40UN_AC	4	2,1	3	6,67	50
40	No.5 (1,5xD)		NB04023C5_40UN_AC	4	2,3	3	5,4	50
40	No.5 (2xD)		NB04023C7_40UN_AC	4	2,3	3	7,3	50
40	No.5 (2,5xD)		NB04023C8_40UN_AC	4	2,3	3	8,57	50
40		No.6 (1,5xD)	NB04026C6_40UN_AC	4	2,6	3	6,03	50
40		No.6 (2xD)	NB04026C8_40UN_AC	4	2,6	3	7,94	50
36		No.8 (1,5xD)	NB04031C7_36UN_AC	4	3,1	3	7,41	50
36		No.8 (2xD)	NB04031C9_36UN_AC	4	3,1	3	9,53	50
32	No.6 (1,5xD)		NB04025C6_32UN_AC	4	2,5	3	6,75	50
32	No.6 (2xD)		NB04025C8_32UN_AC	4	2,5	3	8,33	50
32	No.6 (2,5xD)		NB04025C10_32UN_AC	4	2,5	3	9,92	50
32	No.8 (1,5xD)		NB0403C7_32UN_AC	4	3	3	7,54	50
32	No.8 (2xD)		NB0403C9_32UN_AC	4	3	3	9,13	50
32	No.8 (2,5xD)		NB0403C11_32UN_AC	4	3	3	11,51	50
32		No.10 (1,5xD)	NB04036C8_32UN_AC	4	3,6	3	8,33	50
32		No.10 (2xD)	NB04036C10_32UN_AC	4	3,6	3	10,72	50
32			NB0606D13_32UN_AC	6	6	4	13,1	63
28		No.12 (1,5xD)	NB0404C9_28UN_AC	4	4	3	9,52	50
28		No.12 (2xD)	NB0404C12_28UN_AC	4	4	3	12,25	50
28		1/4 (1,5xD)	NB0605C10_28UN_AC	6	5	3	10,43	63
28		1/4 (2xD)	NB0605C14_28UN_AC	6	5	3	14,06	63
28			NB0808D17_28UN_AC	8	8	4	17,69	63
24	No.10 (1,5xD)		NB04036C9_24UN_AC	4	3,6	3	9	50
24	No.10 (2xD)		NB04036C11_24UN_AC	4	3,6	3	11,11	50
24	No.10 (2,5xD)		NB04036C13_24UN_AC	4	3,6	3	13,23	50
24	No.12 (1,5xD)		NB0404C10_24UN_AC	4	4	3	10,05	50
24	No.12 (2xD)		NB0404C12_24UN_AC	4	4	3	12,17	50
24	No.12 (2,5xD)		NB0404C15_24UN_AC	4	4	3	15,35	50
24		5/16 (1,5xD)	NB0606C13_24UN_AC	6	6	3	13,23	63
24		5/16 (2xD)	NB0606C17_24UN_AC	6	6	3	17,46	63
24		3/8 (1,5xD)	NB08076C15_24UN_AC	8	7,6	3	15,35	63
24		3/8 (2xD)	NB08076C20_24UN_AC	8	7,6	3	20,64	76
20	1/4 (1,5xD)		NB06045C10_20UN_AC	6	4,5	3	10,8	63
20	1/4 (2xD)		NB06045C14_20UN_AC	6	4,5	3	14,6	63
20	1/4 (2,5xD)		NB06045C17_20UN_AC	6	4,5	3	17,15	63
20		7/16 (1,5xD)	NB0808C18_20UN_AC	8	8	3	18,41	63
20		7/16 (2xD)	NB0808C23_20UN_AC	8	8	3	23,5	76
20		1/2 (1,5xD)	NB1010D21_20UN_AC	10	10	4	20,96	76
20		1/2 (2xD)	NB1010D27_20UN_AC	10	10	4	27,31	76
20			NB1212E28_20UN_AC	12	12	5	28,57	83
18	5/16 (1,5xD)		NB06058C13_18UN_AC	6	5,8	3	13,41	63
18	5/16 (2xD)		NB06058C17_18UN_AC	6	5,8	3	17,64	63
18	5/16 (2,5xD)		NB06058C21_18UN_AC	6	5,8	3	21,87	63
18		9/16 (1,5xD)	NB1010D23_18UN_AC	10	10	4	23,28	76
18		9/16 (2xD)	NB1010D30_18UN_AC	10	10	4	30,34	100
18		5/8 (1,5xD)	NB1212D26_18UN_AC	12	12	4	26,11	83
18		5/8 (2xD)	NB1212D33_18UN_AC	12	12	4	33,16	100

continue

UN

UNIFIED

Pitch TPI	UNC	UNF	INTERNAL Part Number	d mm	D mm	No. of Flutes	l mm	L mm
16	3/8 (1,5xD)		NB0606C16_16UN_AC	6	6	3	16,67	63
16	3/8 (2xD)		NB0606C21_16UN_AC	6	6	3	21,43	63
16	3/8 (2,5xD)		NB0807C26_16UN_AC	8	7	3	26,19	76
16		3/4 (1,5xD)	NB1212D31_16UN_AC	12	12	4	30,96	100
16		3/4 (2xD)	NB1212D40_16UN_AC	12	12	4	40,48	100
16			NB1616E35_16UN_AC	16	16	5	35,72	100
14	7/16 (1,5xD)		NB0808C19_14UN_AC	8	8	3	19,05	63
14	7/16 (2xD)		NB0808C24_14UN_AC	8	8	3	24,49	76
14	7/16 (2,5xD)		NB0808C30_14UN_AC	8	8	3	29,94	76
14		7/8 (1,5xD)	NB1616E35_14UN_AC	16	16	5	35,38	100
14		7/8 (2xD)	NB1616E46_14UN_AC	16	16	5	46,26	120
13	1/2 (1,5xD)		NB0808C22_13UN_AC	8	8	3	22,47	76
13	1/2 (2xD)		NB0808C28_13UN_AC	8	8	3	28,33	76
13	1/2 (2,5xD)		NB10093C34_13UN_AC	10	9,3	3	34,19	100
12	9/16 (1,5xD)		NB1010C24_12UN_AC	10	10	3	24,34	76
12	9/16 (2xD)		NB1010C30_12UN_AC	10	10	3	30,69	100
12			NB1616E43_12UN_AC	16	16	5	43,39	100
11	5/8 (1,5xD)		NB1010C26_11UN_AC	10	10	3	26,55	76
11	5/8 (2xD)		NB1010C35_11UN_AC	10	10	3	35,79	100
11	5/8 (2,5xD)		NB12117C42_11UN_AC	12	11,7	3	42,72	100
10	3/4 (1,5xD)		NB1212C31_10UN_AC	12	12	3	31,75	100
10	3/4 (2xD)		NB1212C41_10UN_AC	12	12	3	41,91	100
9	7/8 (1,5xD)		NB1616C38_9UN_AC	16	16	3	38,1	100
9	7/8 (2xD)		NB1616C49_9UN_AC	16	16	3	49,39	120
8	1 (1,5xD)		NB1616C42_8UN_AC	16	16	3	42,86	100
8	1 (2xD)		NB1616C55_8UN_AC	16	16	3	55,56	120
8			NB2020D49_8UN_AC	20	20	4	49,21	120
7	1 1/8 - 1 1/4 (1,5xD)		NB2020C52_7UN_AC	20	20	3	52,61	120
6	1 3/8 - 1 1/2 (1,5xD)		NB2525C61_6UN_AC	25	25	3	61,38	130

G/Rp

WHITWORTH PIPE THREAD

Pitch TPI	Standard	INTERNAL / EXTERNAL Part Number	d mm	D mm	No. of Flutes	l mm	L mm
28	G 1/16 - 1/8	XB0606C10_28W_AC	6	6	3	10,43	63
28	G 1/8	XB0808D14_28W_AC	8	8	4	14,06	63
19	G 1/4 - 3/8	XB0808C15_19W_AC	8	8	3	15,37	63
19	G 1/4 - 3/8	XB1010D22_19W_AC	10	10	4	22,06	76
14	G 1/2 - 7/8	XB1212D20_14W_AC	12	12	4	20,86	83
14	G 1/2 - 7/8	XB1212D28_14W_AC	12	12	4	28,12	83
14	G 1/2 - 7/8	XB1616E28_14W_AC	16	16	5	28,12	89
11	G 1 - 1 1/2	XB1212C26_11W_AC	12	12	3	26,55	83
11	G 1 - 3	XB1616D40_11W_AC	16	16	4	40,41	100
11	G ≥ 1	XB2020E49_11W_AC	20	20	5	49,65	120

R/Rc

BSPT PIPE THREAD

Pitch TPI	Standard	INTERNAL / EXTERNAL Part Number	d mm	D mm	No. of Flutes	l mm	L mm
28	Rc 1/16 - 1/8	XB0606C10_28BSPT_AC	6	6	3	10,43	63
28	Rc 1/8	XB0808D14_28BSPT_AC	8	8	4	14,06	63
19	Rc 1/4 - 3/8	XB0808C15_19BSPT_AC	8	8	3	15,37	63
19	Rc 1/4 - 3/8	XB1010D22_19BSPT_AC	10	10	4	22,06	76
14	Rc 1/2 - 7/8	XB1212D20_14BSPT_AC	12	12	4	20,86	83
11	Rc 1 - 2	XB1616D31_11BSPT_AC	16	16	4	31,17	89

PG

STEEL CONDUIT THREAD DIN 40430

Pitch TPI	Standard	INTERNAL / EXTERNAL Part Number	d mm	D mm	No. of Flutes	l mm	L mm
20	Pg 7	XB0808C21_20PG_AC	8	8	3	20,96	63
18	Pg 9 - 16	XB1010C27_18PG_AC	10	10	3	27,52	76
16	Pg 21- 48	XB1212D31_16PG_AC	12	12	4	30,96	83

NPSF

NPSF PIPE THREAD

Pitch TPI	Standard	INTERNAL / EXTERNAL Part Number	d mm	D mm	No. of Flutes	l mm	L mm
27	1/16 - 1/8	XB0606C12_27NPSF_AC	6	6	3	12,70	63
18	1/4 - 3/8	XB0808C16_18NPSF_AC	8	8	3	16,23	63
14	1/2 - 3/4	XB1212D22_14NPSF_AC	12	12	4	22,68	83
11,5	1	XB1616D29_11.5NPSF_AC	16	16	4	29,82	89

NPT

NPT PIPE THREAD

Pitch TPI	Standard	INTERNAL / EXTERNAL Part Number	d mm	D mm	No. of Flutes	l mm	L mm
27	1/16 - 1/8	XB0606C10_27NPT_AC	6	6	3	10,82	63
18	1/4 - 3/8	XB0808C16_18NPT_AC	8	8	3	16,23	63
18	1/4 - 3/8	XB1010D16_18NPT_AC	10	10	4	16,23	76
14	1/2 - 3/4	XB1212D22_14NPT_AC	12	12	4	22,68	83
14	3/4	XB1616E22_14NPT_AC	16	16	5	22,68	89
11,5	1 - 2	XB1616D29_11.5NPT_AC	16	16	4	29,82	89
8	≥ 2 1/2	XB2020D42_8NPT_AC	20	20	4	42,86	100

NPTF

NPTF DRYSEAL PIPE THREAD

Pitch TPI	Standard	INTERNAL / EXTERNAL Part Number	d mm	D mm	No. of Flutes	l mm	L mm
27	1/16 - 1/8	XB0606C10_27NPTF_AC	6	6	3	10,82	63
18	1/4 - 3/8	XB0808C16_18NPTF_AC	8	8	3	16,23	63
14	1/2 - 3/4	XB1212D22_14NPTF_AC	12	12	4	22,68	83
11,5	1 - 2	XB1616D29_11.5NPTF_AC	16	16	4	29,82	89
8	≥ 2 1/2	XB2020D42_8NPTF_AC	20	20	4	42,86	100

Tapered End Mills for NPT/NPTF/BSPT

FC
TiAlN coated
Micrograin Carbide
Tolerance
D 5,0 - 17,0 +0 / -0,050
Shank
Cylindrical h6, DIN6535 HA
Flute
30° right hand spiral
Field of application
Before Thread Milling of
NPT/NPTF/BSPT

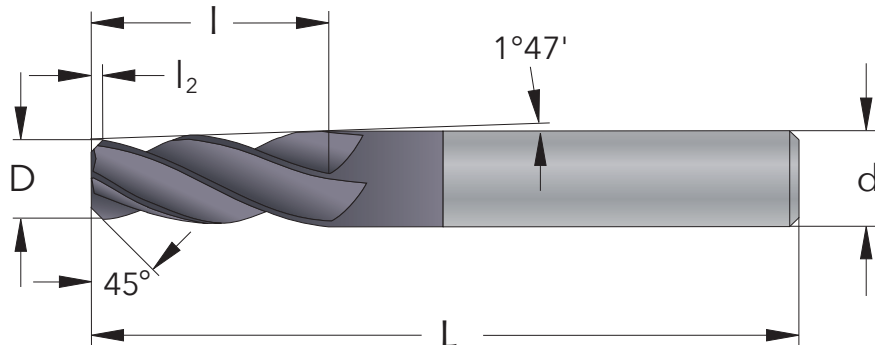

D mm	d mm	Part Number	No. of Flutes	l mm	l ₂ mm	L mm
5	6	NPT0605D16_FC	4	16	1,0	63
8,5	10	NPT10085D24_FC	4	24	1,5	76
14	16	NPT1614D32_FC	4	32	2	89
17	20	NPT2017D48_FC	4	48	3	120

with Chamfer

AC

TiAlCN coated
Micrograin Carbide

Tolerance

The theoretical external diameter of the cutter is lasermarked on the tool.

Shank

Cylindrical h6, DIN6535 HA

Flute

15° right hand spiral

Field of application

Thread Milling of all types of steel

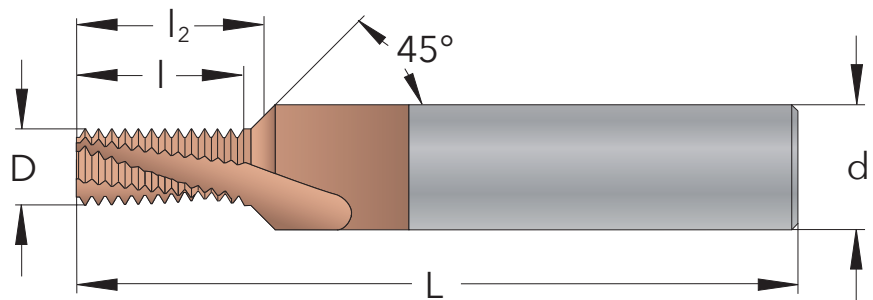
**M****METRIC**

Pitch mm	M coarse	INTERNAL Part Number	d mm	D mm	No. of Flutes	l mm	l ₂ mm	L mm
0,5	M3 (1,5xD)	NF06023C5_0.5ISO_AC	6	2,3	3	5,25	5,85	63
0,5	M3 (2xD)	NF06023C6_0.5ISO_AC	6	2,3	3	6,75	7,35	63
0,5	M3 (2,5xD)	NF06023C8_0.5ISO_AC	6	2,3	3	8,25	8,85	63
0,5	M3 (3xD)	NF06023C9_0.5ISO_AC	6	2,3	3	9,75	10,35	63
0,7	M4 (1,5xD)	NF0603C7_0.7ISO_AC	6	3	3	7,35	8,2	63
0,7	M4 (2xD)	NF0603C8_0.7ISO_AC	6	3	3	8,75	9,6	63
0,7	M4 (2,5xD)	NF0603C10_0.7ISO_AC	6	3	3	10,85	11,7	63
0,7	M4 (3xD)	NF0603C12_0.7ISO_AC	6	3	3	12,95	13,8	63
0,8	M5 (1,5xD)	NF06038C8_0.8ISO_AC	6	3,8	3	8,4	9,4	63
0,8	M5 (2xD)	NF06038C10_0.8ISO_AC	6	3,8	3	10,8	11,8	63
0,8	M5 (2,5xD)	NF06038C13_0.8ISO_AC	6	3,8	3	13,2	14,2	63
0,8	M5 (3xD)	NF06038C16_0.8ISO_AC	6	3,8	3	16,4	17,4	63
1,0	M6 (1,5xD)	NF08045C10_1.0ISO_AC	8	4,5	3	10,5	11,75	63
1,0	M6 (2xD)	NF08045C13_1.0ISO_AC	8	4,5	3	13,5	14,75	63
1,0	M6 (2,5xD)	NF08045C16_1.0ISO_AC	8	4,5	3	16,5	17,75	63
1,25	M8 (1,5xD)	NF1006C14_1.25ISO_AC	10	6	3	14,37	16	76
1,25	M8 (2xD)	NF1006C18_1.25ISO_AC	10	6	3	18,12	19,75	76
1,25	M8 (2,5xD)	NF1006C21_1.25ISO_AC	10	6	3	21,87	23,5	76
1,5	M10 (1,5xD)	NF12075C17_1.5ISO_AC	12	7,5	3	17,25	19,25	83
1,5	M10 (2xD)	NF12075C21_1.5ISO_AC	12	7,5	3	21,75	23,75	83
1,5	M10 (2,5xD)	NF12075C27_1.5ISO_AC	12	7,5	3	27,75	29,75	83
1,75	M12 (1,5xD)	NF1409C20_1.75ISO_AC	14	9	3	20,12	22,5	89
1,75	M12 (2xD)	NF1409C27_1.75ISO_AC	14	9	3	27,12	29,5	89
1,75	M12 (2,5xD)	NF1409C32_1.75ISO_AC	14	9	3	32,37	34,75	89

Chamfering of the thread

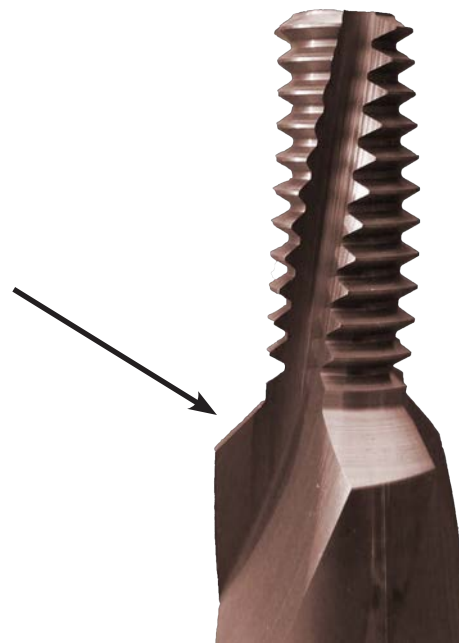

ThreadBurr with Internal Coolant

AC
 TiAlCN coated
 Micrograin Carbide
Tolerance
 The theoretical external diameter of the cutter is lasermarked on the tool.
Shank
 Cylindrical h6, DIN6535 HA
Flute
 15° right hand spiral
Field of application
 Thread Milling of all types of steel

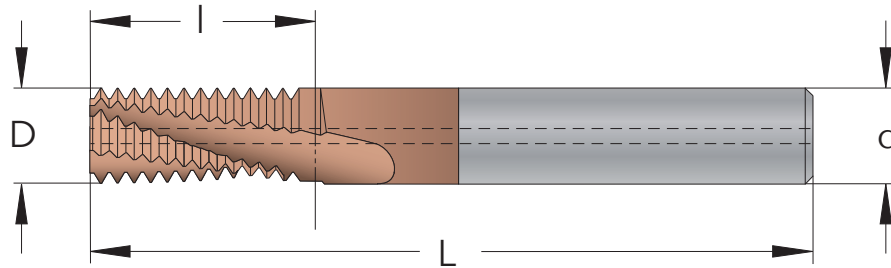

M METRIC

Pitch mm	M coarse	M fine	INTERNAL Part Number	d mm	D mm	No. of Flutes	l mm	L mm
0,8	M5 (1,5xD)		NBK04038C8_0.8ISO_AC	4	3,8	3	8,4	50
0,8	M5 (2xD)		NBK04038C10_0.8ISO_AC	4	3,8	3	10,8	50
0,8	M5 (2,5xD)		NBK04038C13_0.8ISO_AC	4	3,8	3	13,2	50
1,0	M6 (1,5xD)	≥ M8	NBK06045C10_1.0ISO_AC	6	4,5	3	10,5	63
1,0	M6 (2xD)	≥ M8	NBK06045C13_1.0ISO_AC	6	4,5	3	13,5	63
1,0	M6 (2,5xD)	≥ M8	NBK06045C16_1.0ISO_AC	6	4,5	3	16,5	63
1,0		≥ M10	NBK0808D17_1.0ISO_AC	8	8	3	17,5	76
1,25	M8 (1,5xD)	≥ M10	NBK0606C14_1.25ISO_AC	6	6	3	14,37	63
1,25	M8 (2xD)	≥ M10	NBK0606C18_1.25ISO_AC	6	6	3	18,12	63
1,25	M8 (2,5xD)	≥ M10	NBK0606C21_1.25ISO_AC	6	6	3	21,87	63
1,5	M10 (1,5xD)	≥ M12	NBK08075C17_1.5ISO_AC	8	7,5	3	17,25	76
1,5	M10 (2xD)	≥ M12	NBK08075C21_1.5ISO_AC	8	7,5	3	21,75	76
1,5	M10 (2,5xD)	≥ M12	NBK08075C27_1.5ISO_AC	8	7,5	3	27,75	76
1,5	M10 (3xD)	≥ M12	NBK08075C32_1.5ISO_AC	8	7,5	3	32,25	76
1,5		≥ M16	NBK1212E29_1.5ISO_AC	12	12	5	29,25	100
1,5		≥ M20	NBK1616F35_1.5ISO_AC	16	16	6	35,25	120
1,75	M12 (1,5xD)		NBK0808C20_1.75ISO_AC	8	8	3	20,12	76
1,75	M12 (2xD)		NBK0808C27_1.75ISO_AC	8	8	3	27,12	76
1,75	M12 (1,5xD)		NBK1009C20_1.75ISO_AC	10	9	3	20,12	100
1,75	M12 (2xD)		NBK1009C27_1.75ISO_AC	10	9	3	27,12	100
1,75	M12 (2,5xD)		NBK1009C32_1.75ISO_AC	10	9	3	32,37	100
1,75	M12 (3xD)		NBK1009C37_1.75ISO_AC	10	9	3	37,62	100
2,0	M14 (1,5xD)	≥ M18	NBK1010C23_2.0ISO_AC	10	10	3	23	100
2,0	M14 (2xD)	≥ M18	NBK1010C31_2.0ISO_AC	10	10	3	31	100
2,0	M16 (1,5xD)	≥ M18	NBK1212D27_2.0ISO_AC	12	12	4	27	100
2,0	M16 (2xD)	≥ M18	NBK1212D35_2.0ISO_AC	12	12	4	35	100
2,0	M16 (2,5xD)	≥ M18	NBK1212D43_2.0ISO_AC	12	12	4	43	100
2,0	M16 (3xD)	≥ M18	NBK1212C51_2.0ISO_AC	12	12	3	51	100
2,0		≥ M20	NBK1616E39_2.0ISO_AC	16	16	5	39	120
2,5	M20 (1,5xD)		NBK1414D33_2.5ISO_AC	14	14	4	33,75	100
2,5	M20 (2xD)		NBK1414D43_2.5ISO_AC	14	14	4	43,75	100
2,5	M20 (2,5xD)		NBK1615D53_2.5ISO_AC	16	15	4	53,75	120
3,0	M24 (1,5xD)	≥ M30	NBK1616C40_3.0ISO_AC	16	16	3	40,5	120
3,0	M24 (2xD)	≥ M30	NBK1616C52_3.0ISO_AC	16	16	3	52,5	120
3,5	M30 (1,5xD)		NBK2020C50_3.5ISO_AC	20	20	3	50,75	150
3,5	M30 (2xD)		NBK2020C64_3.5ISO_AC	20	20	3	64,75	150

Internal Coolant

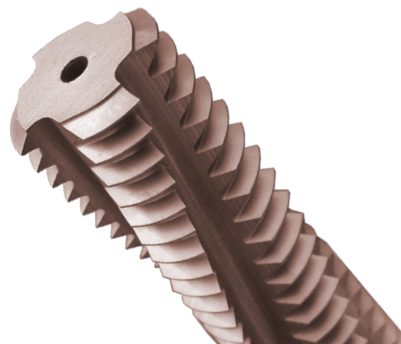

AC

TiAlCN coated
Micrograin Carbide

Tolerance

The theoretical external diameter of the cutter is lasermarked on the tool.

Shank

Cylindrical h6, DIN6535 HA

Flute

15° right hand spiral

Field of application

Thread Milling of all types of steel

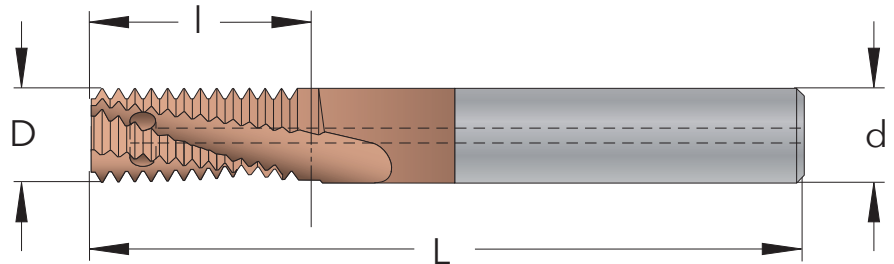
**M****METRIC**

Pitch mm	M coarse	M fine	INTERNAL Part Number	d mm	D mm	No. of Flutes	l mm	L mm
1,0		≥ M10	NBT0808D17_1.0ISO_AC	8	8	4	17,5	76
1,25	M8 (2xD)	≥ M10	NBT0606C18_1.25ISO_AC	6	6	3	18,12	76
1,5	M10 (2xD)	≥ M12	NBT08075C21_1.5ISO_AC	8	7,5	3	21,75	76
1,5		≥ M16	NBT1212E29_1.5ISO_AC	12	12	5	29,25	100
1,75	M12 (2xD)		NBT0808C27_1.75ISO_AC	8	8	3	27,12	76
1,75	M12 (2xD)		NBT1009C27_1.75ISO_AC	10	9	3	27,12	100
2,0	M14 (2xD)	≥ M18	NBT1010C31_2.0ISO_AC	10	10	3	31	100
2,0	M16 (2xD)	≥ M18	NBT1212D35_2.0ISO_AC	12	12	4	35	100
2,0		≥ M20	NBT1616E39_2.0ISO_AC	16	16	5	39	100

G/Rp**WHITWORTH PIPE THREAD**

Pitch TPI	Standard	INTERNAL / EXTERNAL Part Number	d mm	D mm	No. of Flutes	l mm	L mm
28	G 1/16 - 1/8	XBT0606C10_28W_AC	6	6	3	10,43	76
19	G 1/4 - 3/8	XBT1010D22_19W_AC	10	10	4	22,06	100
14	G 1/2 - 7/8	XBT1212D28_14W_AC	12	12	4	28,12	100
11	G 1 - 3	XBT1616D40_11W_AC	16	16	4	40,41	100

Internal Radial Coolant



with One Tooth

AC / LC

TiAlCN / AlCrN coated
Micrograin Carbide

Tolerance

D 0,3 - 6,0 +0 / -0,020
D 7,0 - 12,0 +0 / -0,030

Shank

Cylindrical h6, DIN6535 HA

Flute

15° right hand spiral

Field of application

Thread Milling of all types of steel

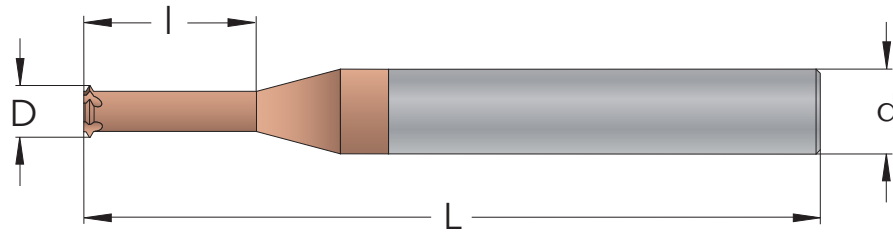

60°

PARTIAL PROFILE 60°

M coarse	M pitch mm	UNC	UNF	UN pitch TPI	INTERNAL Part Number	d mm	D mm	No. of Flutes	l mm	L mm
M0,5 (2xD)	0,125		No. 0000	160	NS03003C1.3_P60_LC	3	0,37	3	1,3	39
M0,6 (2xD)	0,15				NS03004C1.5_P60_LC	3	0,44	3	1,5	39
M0,8 (2xD)	0,2		No. 000	120	NS03005C2.0_P60_LC	3	0,58	3	2	39
M0,8 (3xD)	0,2		No. 000	120	NS03005C2.7_P60_LC	3	0,58	3	2,7	39
M1 (2xD)	0,2 - 0,25				NS03007C2.5_P60_LC	3	0,72	3	2,5	39
M1 (3xD)	0,2 - 0,25				NS03007C3.2_P60_LC	3	0,72	3	3,2	39
M1,2 (2xD)	0,2 - 0,25		No. 00	95	NS03009C2.9_P60_LC	3	0,92	3	2,9	39
M1,2 (3xD)	0,2 - 0,25		No. 00	95	NS03009C3.9_P60_LC	3	0,92	3	3,9	39
M1,4 (2xD)	0,2 - 0,3				NS03010C3.3_P60_LC	3	1,06	3	3,3	39
M1,4 (3xD)	0,2 - 0,3				NS03010C4.4_P60_LC	3	1,06	3	4,4	39
M1,6 (2xD)	0,2 - 0,35		No. 0	80	NS03012D3.6_P60_LC	3	1,2	4	3,6	39
M1,6 (3xD)	0,2 - 0,35		No. 0	80	NS03012D5.1_P60_LC	3	1,2	4	5,1	39
M1,8 (2xD)	0,35 - 0,4	No. 1	No. 1	64 - 72	NS03014D4.2_P60_LC	3	1,4	4	4,2	39
M1,8 (3xD)	0,35 - 0,4	No. 1	No. 1	64 - 72	NS03014D5.6_P60_LC	3	1,4	4	5,6	39
M2 (2xD)	0,4		No. 2	64	NS03015D4.6_P60_LC	3	1,55	4	4,6	39
M2 (3xD)	0,4		No. 2	64	NS03015D6.2_P60_LC	3	1,55	4	6,2	39
M2 (2xD)	0,35 - 0,4		No. 2	64	NS04015D4_P60_AC	4	1,5	4	4,4	50
M2 (3xD)	0,35 - 0,4		No. 2	64	NS04015D6_P60_AC	4	1,5	4	6,4	50
M2,2 (2xD)	0,45	No. 2		56	NS04016D5_P60_AC	4	1,65	4	5	50
M2,2 (3xD)	0,45	No. 2		56	NS04016D7_P60_AC	4	1,65	4	7,1	50
M2,5 (2xD)	0,45 - 0,5	No. 3	No. 3 - 4	56 - 48	NS04019D5_P60_AC	4	1,9	4	5,5	50
M2,5 (3xD)	0,45 - 0,5	No. 3	No. 3 - 4	56 - 48	NS04019D8_P60_AC	4	1,9	4	8	50
		No. 4		40	NS04021D6_P60_AC	4	2,1	4	6,4	50
		No. 4		40	NS04021D9_P60_AC	4	2,1	4	9,2	50
M3 (2xD)	0,5 - 0,6	No. 5	No. 5	44 - 40	NS04023D6_P60_AC	4	2,3	4	6,5	50
M3 (3xD)	0,5 - 0,6	No. 5	No. 5	44 - 40	NS04023D9_P60_AC	4	2,3	4	9,5	50
M3,5 (2xD)	0,5 - 0,75	No. 6	No. 6	40 - 32	NS04026D7_P60_AC	4	2,6	4	7,6	50
M3,5 (3xD)	0,5 - 0,75	No. 6	No. 6	40 - 32	NS04026D11_P60_AC	4	2,6	4	11,1	50
M4 (2xD)	0,7 - 0,75	No. 8	No. 8	36 - 32	NS0403D9_P60_AC	4	3	4	9	50
M4 (3xD)	0,7 - 0,75	No. 8	No. 8	36 - 32	NS0403D13_P60_AC	4	3	4	13	50
M4,5 (2xD)	0,75 - 1,0	No. 10	No. 10	32 - 24	NS04036D10_P60_AC	4	3,6	4	10	50
M4,5 (3xD)	0,75 - 1,0	No. 10	No. 10	32 - 24	NS04036D14_P60_AC	4	3,6	4	14,3	50
M5 (2xD)	0,75 - 1,0	No. 12	No. 12 - 1/4	32 - 24	NS0404D11_P60_AC	4	4	4	11	50
M5 (3xD)	0,75 - 1,0	No. 12	No. 12 - 1/4	32 - 24	NS0404D16_P60_AC	4	4	4	16	50
M6 (2xD)	1,0 - 1,25	1/4	5/16 - 3/8	24 - 20	NS06045D13_P60_AC	6	4,5	4	13	63
M6 (3xD)	1,0 - 1,25	1/4	5/16 - 3/8	24 - 20	NS06045D19_P60_AC	6	4,5	4	19	76
M8 (2xD)	1,25	5/16	7/16 - 1/2	20 - 18	NS0606E17_P60_AC	6	6	5	17,3	63
M8 (3xD)	1,25	5/16	7/16 - 1/2	20 - 18	NS0606E25_P60_AC	6	6	5	25,3	76
M10 (2xD)	1,5	3/8	9/16 - 3/4	18 - 16	NS08075E22_P60_AC	8	7,5	5	22	63
M10 (3xD)	1,5	3/8	9/16 - 3/4	18 - 16	NS08075E32_P60_AC	8	7,5	5	32	76
M12 (2xD)	1,75	7/16 - 1/2	7/8	14 - 13	NS1009E26_P60_AC	10	9	5	26	76
M12 (3xD)	1,75	7/16 - 1/2	7/8	14 - 13	NS1009E38_P60_AC	10	9	5	38	100
M14 (2xD)	2,0	9/16	≥ 1	12	NS1010E30_P60_AC	10	10	5	30	76
M14 (3xD)	2,0	9/16	≥ 1	12	NS1010E44_P60_AC	10	10	5	44	100
M16 (2xD)	2,0	5/8	≥ 1	12 - 11	NS1212F34_P60_AC	12	12	6	34	83
M16 (3xD)	2,0	5/8	≥ 1	12 - 11	NS1212F50_P60_AC	12	12	6	50	100

with One Tooth

M

METRIC

Pitch mm	M coarse	M fine	INTERNAL Part Number	d mm	D mm	No. of Flutes	l mm	L mm
0,25	M1 (2xD)	≥ M1,4	NS03007C2_0.25ISO_LC	3	0,72	3	2,5	39
0,25	M1 (3xD)	≥ M1,4	NS03007C3_0.25ISO_LC	3	0,72	3	3,5	39
0,25	M1,2 (2xD)	≥ M1,4	NS03009C2_0.25ISO_LC	3	0,92	3	2,9	39
0,25	M1,2 (3xD)	≥ M1,4	NS03009C3_0.25ISO_LC	3	0,92	3	3,9	39
0,3	M1,4 (2xD)		NS03010C3_0.3ISO_LC	3	1,06	3	3,3	39
0,3	M1,4 (3xD)		NS03010C4_0.3ISO_LC	3	1,06	3	4,4	39
0,35	M1,6 (2xD)	≥ M2	NS03012D3_0.35ISO_LC	3	1,2	4	3,6	39
0,35	M1,6 (3xD)	≥ M2	NS03012D5_0.35ISO_LC	3	1,2	4	5,1	39
0,35	M1,8 (2xD)	≥ M2	NS03014D4_0.35ISO_LC	3	1,4	4	4,2	39
0,35	M1,8 (3xD)	≥ M2	NS03014D5_0.35ISO_LC	3	1,4	4	5,6	39
0,4	M2 (2xD)		NS03015D4_0.4ISO_LC	3	1,55	4	4,7	39
0,4	M2 (3xD)		NS03015D6_0.4ISO_LC	3	1,55	4	6,2	39

with Two Teeth

AC

TiAlCN coated

Micrograin Carbide

Tolerance

The theoretical external diameter of the cutter is lasermarked on the tool.

Shank

Cylindrical h6, DIN6535 HA

Flute

15° right hand spiral

Field of application

Thread Milling of all types of steel

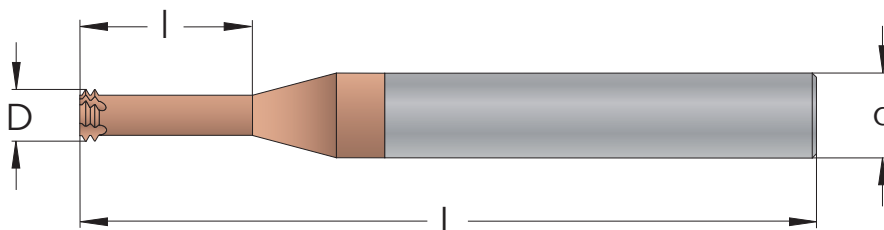

M

METRIC

Pitch mm	M coarse	M fine	INTERNAL Part Number	d mm	D mm	No. of Flutes	l mm	L mm
0,4	M2 (2xD)		NM04015D4_0.4ISO_AC	4	1,5	4	4,4	50
0,4	M2 (3xD)		NM04015D6_0.4ISO_AC	4	1,5	4	6,4	50
0,45	M2,2 (2xD)		NM04016D5_0.45ISO_AC	4	1,65	4	5,0	50
0,45	M2,2 (3xD)		NM04016D7_0.45ISO_AC	4	1,65	4	7,1	50
0,45	M2,5 (2xD)		NM04019D5_0.45ISO_AC	4	1,9	4	5,5	50
0,45	M2,5 (3xD)		NM04019D8_0.45ISO_AC	4	1,9	4	8	50
0,5	M3 (2xD)	≥ M3,5	NM04023E6_0.5ISO_AC	4	2,3	5	6,5	50
0,5	M3 (3xD)	≥ M3,5	NM04023E9_0.5ISO_AC	4	2,3	5	9,5	50
0,6	M3,5 (2xD)		NM04026E7_0.6ISO_AC	4	2,6	5	7,6	50
0,6	M3,5 (3xD)		NM04026E11_0.6ISO_AC	4	2,6	5	11,1	50
0,7	M4 (2xD)		NM0403E9_0.7ISO_AC	4	3	5	9	50
0,7	M4 (3xD)		NM0403E13_0.7ISO_AC	4	3	5	13	50
0,75	M4,5 (2xD)	≥ M5	NM04034E10_0.75ISO_AC	4	3,4	5	10	50
0,75	M4,5 (3xD)	≥ M5	NM04034E14_0.75ISO_AC	4	3,4	5	14,3	50
0,8	M5 (2xD)		NM04038E11_0.8ISO_AC	4	3,8	5	11	50
0,8	M5 (3xD)		NM04038E16_0.8ISO_AC	4	3,8	5	16	50
1,0	M6 (2xD)	≥ M8	NM06045E13_1.0ISO_AC	6	4,5	5	13	63
1,0	M6 (3xD)	≥ M8	NM06045E19_1.0ISO_AC	6	4,5	5	19	76
1,25	M8 (2xD)	≥ M10	NM0606E17_1.25ISO_AC	6	6	5	17,3	63
1,25	M8 (3xD)	≥ M10	NM0606E25_1.25ISO_AC	6	6	5	25,3	76
1,5	M10 (2xD)	≥ M12	NM08075E22_1.5ISO_AC	8	7,5	5	22	63
1,5	M10 (3xD)	≥ M12	NM08075E32_1.5ISO_AC	8	7,5	5	32	76
1,75	M12 (2xD)		NM1009E26_1.75ISO_AC	10	9	5	26	76
1,75	M12 (3xD)		NM1009E38_1.75ISO_AC	10	9	5	38	100
2,0	M14 (2xD)	≥ M18	NM1010E30_2.0ISO_AC	10	10	5	30	76
2,0	M14 (3xD)	≥ M18	NM1010E44_2.0ISO_AC	10	10	5	44	100
2,0	M16 (2xD)	≥ M18	NM1212F34_2.0ISO_AC	12	12	6	34	83
2,0	M16 (3xD)	≥ M18	NM1212F50_2.0ISO_AC	12	12	6	50	100

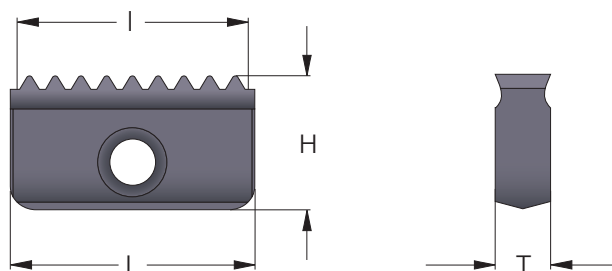

M METRIC

Pitch mm	M coarse	M fine	INTERNAL Part Number	I mm	L mm	T mm	H mm	Cutting Edges
1,0		≥ M16	14I_1.0ISO_FC	14	14	3,1	7,5	2
1,0		≥ M24	21I_1.0ISO_FC	21	21	4,7	12	2
1,5		≥ M16	14I_1.5ISO_FC	13,5	14	3,1	7,5	2
1,5		≥ M24	21I_1.5ISO_FC	21	21	4,7	12	2
1,5		≥ M35	30I_1.5ISO_FC	30	30	5,5	16	2
2,0	M16	≥ M18	14I_2.0ISO_FC	14	14	3,1	7,5	2
2,0		≥ M24	21I_2.0ISO_FC	20	21	4,7	12	2
2,0		≥ M36	30I_2.0ISO_FC	30	30	5,5	16	2
2,0		≥ M56	40I_2.0ISO_FC	40	40	6,3	20	2
2,5	M18-M22		14I_2.5ISO_FC	12,5	14	3,1	7,5	2
3,0	M24	≥ M30	21I_3.0ISO_FC	21	21	4,7	12	2
3,0		≥ M40	30I_3.0ISO_FC	30	30	5,5	16	2
3,0		≥ M58	40I_3.0ISO_FC	39	40	6,3	20	2
3,5	M30-M33		21I_3.5ISO_FC	21	21	4,7	12	2
4,0	M36-M39	≥ M42	30I_4.0ISO_FC	28	30	5,5	16	2
4,0		≥ M64	40I_4.0ISO_FC	40	40	6,3	20	2
4,5	M42-M45		30I_4.5ISO_FC	27	30	5,5	16	2
5,0	M48-M52		30I_5.0ISO_FC	30	30	5,5	16	2
5,5	M56-M60		30I_5.5ISO_FC	27,5	30	5,5	16	2
6,0	M64-M68	≥ M72	40I_6.0ISO_FC	36	40	6,3	20	2

G/Rp WHITWORTH PIPE THREAD

Pitch TPI	Norm	INTERNAL / EXTERNAL Part Number	I mm	L mm	T mm	H mm	Cutting Edges
19	G 3/8	14X_19W_FC	13,37	14	3,1	7,5	2
14	G 1/2 - 5/8	14X_14W_FC	12,7	14	3,1	7,5	2
14	G 3/4 - 7/8	21X_14W_FC	19,96	21	4,7	12	2
11	G 1	14X_11W_FC	13,85	14	3,1	7,5	1
11	G 1	21X_11W_FC	20,78	21	4,7	12	2
11	G 1 1/8	30X_11W_FC	30,02	30	5,5	16	2
11	G ≥ 2	40X_11W_FC	39,25	40	6,3	20	2

R/Rc BSPT PIPE THREAD

Pitch TPI	Norm	INTERNAL / EXTERNAL Part Number	I mm	L mm	T mm	H mm	Cutting Edges
19	Rc 3/8	14X_19BSPT_FC	13,37	14	3,1	7,5	1
14	Rc 1/2 - 5/8	14X_14BSPT_FC	12,7	14	3,1	7,5	1
14	Rc 3/4 - 7/8	21X_14BSPT_FC	19,96	21	4,7	12	1
11	Rc 1	21X_11BSPT_FC	20,78	21	4,7	12	1
11	Rc 1 1/8	30X_11BSPT_FC	30,02	30	5,5	16	1
11	Rc ≥ 2	40X_11BSPT_FC	39,25	40	6,3	20	1

PG STEEL CONDUIT THREAD DIN 40430

Pitch TPI	Norm	INTERNAL / EXTERNAL Part Number	I mm	L mm	T mm	H mm	Cutting Edges
18	Pg 9 - 16	14X_18PG_FC	14,11	14	3,1	7,5	2
18	Pg 13,5 - 16	21X_18PG_FC	21	21	4,7	12	2
16	Pg 21 - 48	21X_16PG_FC	20,64	21	4,7	12	2
16	Pg 29 - 48	30X_16PG_FC	30	30	5,5	16	2

UN

UNIFIED

Pitch TPI	UNC	UNF	UNEF	INTERNAL Part Number	I mm	L mm	T mm	H mm	Cutting Edges
32				14I_32UN_FC	13,49	14	3,1	7,5	2
28				14I_28UN_FC	13,61	14	3,1	7,5	2
24			5/8	14I_24UN_FC	13,75	14	3,1	7,5	2
20			3/4 - 1	14I_20UN_FC	13,97	14	3,1	7,5	2
20			1	21I_20UN_FC	20,32	21	4,7	12	2
20				30I_20UN_FC	29,21	30	5,5	16	2
18		5/8	1 1/8-1 5/8	14I_18UN_FC	14,11	14	3,1	7,5	2
18			1 1/8-1 5/8	21I_18UN_FC	21,17	21	4,7	12	2
18			1 1/4-1 5/8	30I_18UN_FC	29,63	30	5,5	16	2
16		3/4		14I_16UN_FC	12,7	14	3,1	7,5	2
16				21I_16UN_FC	20,64	21	4,7	12	2
16				30I_16UN_FC	30,16	30	5,5	16	2
16				40I_16UN_FC	39,69	40	6,3	20	2
14		7/8		14I_14UN_FC	12,7	14	3,1	7,5	2
14		7/8		21I_14UN_FC	19,96	21	4,7	12	2
12		1-1 1/2		14I_12UN_FC	12,7	14	3,1	7,5	2
12		1 1/8-1 1/2		21I_12UN_FC	21,12	21	4,7	12	2
12		1 1/2		30I_12UN_FC	29,63	30	5,5	16	2
12				40I_12UN_FC	40,22	40	6,3	20	2
10	3/4			14I_10UN_FC	12,7	14	3,1	7,5	2
8				21I_8UN_FC	19,05	21	4,7	12	2
8				30I_8UN_FC	28,57	30	5,5	16	2
8				40I_8UN_FC	38,1	40	6,3	20	2
7	1 1/8-1 1/4			21I_7UN_FC	21,77	21	4,7	12	2
6	1 1/2			30I_6UN_FC	29,63	30	5,5	16	2
6				40I_6UN_FC	38,1	40	6,3	20	2
5	1 3/4			30I_5UN_FC	30,48	30	5,5	16	1
4	3 - 4			40I_4UN_FC	38,1	40	6,3	20	2

NPT

NPT PIPE THREAD

Pitch TPI	Norm	INTERNAL / EXTERNAL Part Number	I mm	L mm	T mm	H mm	Cutting Edges
18	3/8	14X_18NPT_FC	12,7	14	3,1	7,5	1
14	1/2 - 5/8	14X_14NPT_FC	12,7	14	3,1	7,5	1
14	3/4 - 7/8	21X_14NPT_FC	19,96	21	4,7	12	1
11,5	1	21X_11.5NPT_FC	19,88	21	4,7	12	1
11,5	1 1/4 - 2	30X_11.5NPT_FC	28,71	30	5,5	16	1
8	≥ 2 1/2	30X_8NPT_FC	28,58	30	5,5	16	1
8	≥ 2 1/2	40X_8NPT_FC	38,1	40	6,3	20	1

NPTF

NPTF DRYSEAL PIPE THREAD

Pitch TPI	Norm	INTERNAL / EXTERNAL Part Number	I mm	L mm	T mm	H mm	Cutting Edges
18	3/8	14X_18NPTF_FC	12,7	14	3,1	7,5	1
14	1/2 - 5/8	14X_14NPTF_FC	12,7	14	3,1	7,5	1
14	3/4 - 7/8	21X_14NPTF_FC	19,96	21	4,7	12	1
11,5	1	21X_11.5NPTF_FC	19,88	21	4,7	12	1
11,5	1 1/4 - 2	30X_11.5NPTF_FC	28,71	30	5,5	16	1
8	≥ 2 1/2	30X_8NPTF_FC	28,58	30	5,5	16	1
8	≥ 2 1/2	40X_8NPTF_FC	38,1	40	6,3	20	1

- Part number with I is for internal thread profile.
- Part number with X is for in- and external thread profile.
- For external profile indicate E instead of I. The price is 10% higher for E.

THREAD MILLING CUTTERS

Shank Toolholders with One Pocket

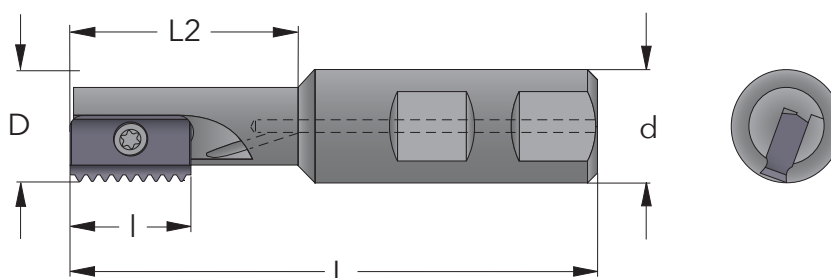

D mm	d mm	Part Number	l mm	L2 mm	L mm	No. of Inserts
12	20	SR0012F14	14	20	75	1
14,5	20	SR0014H14	14	25	85	1
17	20	SR0017H14	14	30	85	1
18	20	SR0018H21	21	30	85	1
21	20	SR0021H21	21	40	94	1
25	20	SR0025K21	21	-	125	1
29	25	SR0029J30	30	50	110	1
31	25	SR0031M30	30	-	150	1
38	32	SR0038M30	30	-	150	1
48	40	SR0048M40	40	78	153	1
48	40	SR0048R40	40	-	210	1

Shank Toolholders with Two Pockets

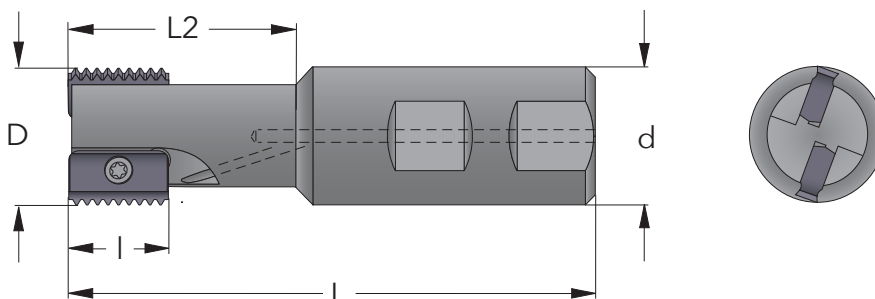

D mm	d mm	Part Number	l mm	L2 mm	L mm	No. of Inserts
20	20	SR0020H14-2	14	41	93	2
30	25	SR0030J21-2	21	52	108	2
40	32	SR0040L30-2	30	70	130	2
50	40	SR0050M40-2	40	78	153	2

THREAD MILLING CUTTERS

Shank Toolholders in Carbide

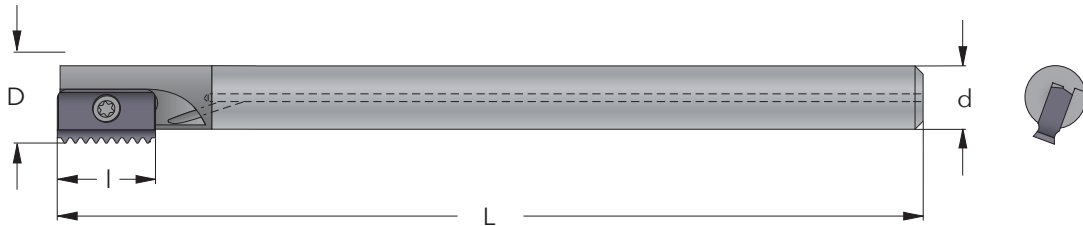

D mm	d mm	Part Number	l mm	L mm	No. of Inserts
13	10	SR0013J14C	14	150	1
15	12	SR0015K14C	14	175	1
21	16	SR0021M21C	21	200	1
27	20	SR0027S30C	30	260	1
33	25	SR0033T30C	30	270	1

Face Mill Cutters

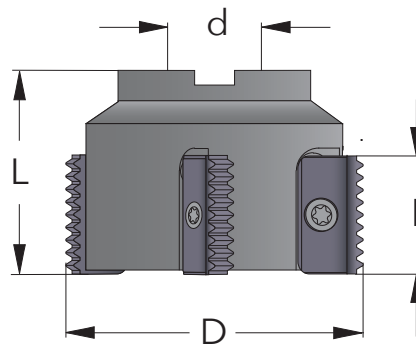

D mm	d mm	Part Number	l mm	L mm	No. of Inserts
63	22	SR0063C21-5	21	50	5
63	22	SR0063C30-4	30	50	4
80	27	SR0080D30-4	30	55	4
100	32	SR0100D30-4	30	60	4
80	27	SR0080D40-4	40	65	4
100	32	SR0100E40-4	40	70	4

Spare Parts

Insert mm	Screw to insert	Torx key
14	S14	K14
21	S21	K21
30	S30	K30
40	S40	K40

Spiral Fluted

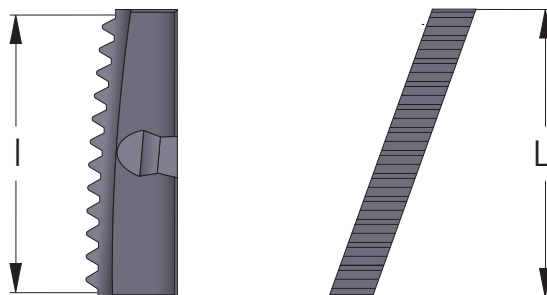

M

METRIC

Pitch mm	M fine	INTERNAL Part Number	l mm	L mm	Cutting Edges
1,0	≥ M27	H23I_1.0ISO_FC	27	27	1
1,5	≥ M27	H23I_1.5ISO_FC	27	27	1
1,5	≥ M36	H32I_1.5ISO_FC	31,5	32	1
1,5	≥ M52	H45I_1.5ISO_FC	36	37	1
1,5	≥ M68	H63I_1.5ISO_FC	37,5	38	1
2,0	≥ M27	H23I_2.0ISO_FC	26	27	1
2,0	≥ M36	H32I_2.0ISO_FC	32	32	1
2,0	≥ M52	H45I_2.0ISO_FC	36	37	1
2,0	≥ M68	H63I_2.0ISO_FC	38	38	1
3,0	≥ M30	H23I_3.0ISO_FC	27	27	1
3,0	≥ M39	H32I_3.0ISO_FC	30	32	1
3,0	≥ M52	H45I_3.0ISO_FC	36	37	1
3,0	≥ M72	H63I_3.0ISO_FC	36	38	1
3,5	≥ M30	H23I_3.5ISO_FC	24,5	27	1
4,0	≥ M36	H23I_4.0ISO_FC	24	27	1
4,0	≥ M42	H32I_4.0ISO_FC	32	32	1
4,0	≥ M56	H45I_4.0ISO_FC	36	37	1
4,0	≥ M72	H63I_4.0ISO_FC	36	38	1
4,5	≥ M42	H32I_4.5ISO_FC	31,5	32	1
5,0	≥ M48	H32I_5.0ISO_FC	30	32	1
5,5	≥ M56	H45I_5.5ISO_FC	33	37	1
6,0	≥ M64	H45I_6.0ISO_FC	36	37	1
6,0	≥ M80	H63I_6.0ISO_FC	36	38	1

G/Rp

WHITWORTH PIPE THREAD

Pitch TPI	Standard	INTERNAL / EXTERNAL Part Number	l mm	L mm	Cutting Edges
14	G ≥ 7/8	H23X_14W_FC	25,4	27	1
11	G ≥ 1	H23X_11W_FC	25,4	27	1
11	G ≥ 1 1/8	H32X_11W_FC	30,02	32	1
11	G ≥ 1 3/4	H45X_11W_FC	36,95	37	1
11	G ≥ 2 1/2	H63X_11W_FC	36,95	38	1

R/Rc

BSPT PIPE THREAD

Pitch TPI	Standard	INTERNAL / EXTERNAL Part Number	l mm	L mm	Cutting Edges
11	Rc ≥ 1	H23X_11BSPT_FC	25,4	27	1
11	Rc ≥ 1 1/8	H32X_11BSPT_FC	30,02	32	1
11	Rc ≥ 1 3/4	H45X_11BSPT_FC	36,95	37	1
11	Rc ≥ 2 1/2	H63X_11BSPT_FC	36,95	38	1

NPT

NPT PIPE THREAD

Pitch TPI	Standard	INTERNAL / EXTERNAL Part Number	l mm	L mm	Cutting Edges
11,5	1 - 2	H23X_11.5NPT_FC	26,5	27	1
11,5	1 ¹ / ₄ - 2	H32X_11.5NPT_FC	30,92	32	1
11,5	2	H45X_11.5NPT_FC	35,34	37	1
8	2 ¹ / ₂	H45X_8NPT_FC	34,93	37	1
8	3	H63X_8NPT_FC	38,1	38	1

NPTF

NPTF PIPE THREAD

Pitch TPI	Standard	INTERNAL / EXTERNAL Part Number	l mm	L mm	Cutting Edges
11,5	1 - 2	H23X_11.5NPTF_FC	26,5	27	1
11,5	1 ¹ / ₄ - 2	H32X_11.5NPTF_FC	30,92	32	1

UN

UNIFIED

Pitch TPI	Standard	INTERNAL Part Number	l mm	L mm	Cutting Edges
24	≥ 1	H23I_24UN_FC	26,46	27	1
20	≥ 1 ¹ / ₁₆	H23I_20UN_FC	26,67	27	1
20	≥ 1 ³ / ₈	H32I_20UN_FC	31,75	32	1
18	≥ 1 ¹ / ₁₆	H23I_18UN_FC	26,81	27	1
18	≥ 1 ³ / ₈	H32I_18UN_FC	31,04	32	1
16	≥ 1 ¹ / ₈	H23I_16UN_FC	26,99	27	1
16	≥ 1 ¹ / ₂	H32I_16UN_FC	31,75	32	1
16	≥ 2	H45I_16UN_FC	36,51	37	1
16	≥ 2 ⁵ / ₈	H63I_16UN_FC	38,1	38	1
12	≥ 1 ¹ / ₈	H23I_12UN_FC	25,4	27	1
12	≥ 1 ¹ / ₂	H32I_12UN_FC	31,75	32	1
12	≥ 2	H45I_12UN_FC	35,98	37	1
12	≥ 2 ³ / ₄	H63I_12UN_FC	38,1	38	1
8	≥ 1 ¹ / ₈	H23I_8UN_FC	25,4	27	1
8	≥ 1 ¹ / ₂	H32I_8UN_FC	31,75	32	1
8	≥ 2 ¹ / ₈	H45I_8UN_FC	34,93	37	1
8	≥ 2 ³ / ₄	H63I_8UN_FC	38,1	38	1
7	≥ 1 ¹ / ₄	H23I_7UN_FC	25,4	27	1
6	≥ 1 ⁵ / ₈	H32I_6UN_FC	29,63	32	1
6	≥ 2 ¹ / ₈	H45I_6UN_FC	33,97	37	1
6	≥ 2 ⁷ / ₈	H63I_6UN_FC	38,1	38	1
5	≥ 1 ³ / ₄	H32I_5UN_FC	30,48	32	1

THREAD MILLING CUTTERS

Spiral Fluted Shank Toolholders

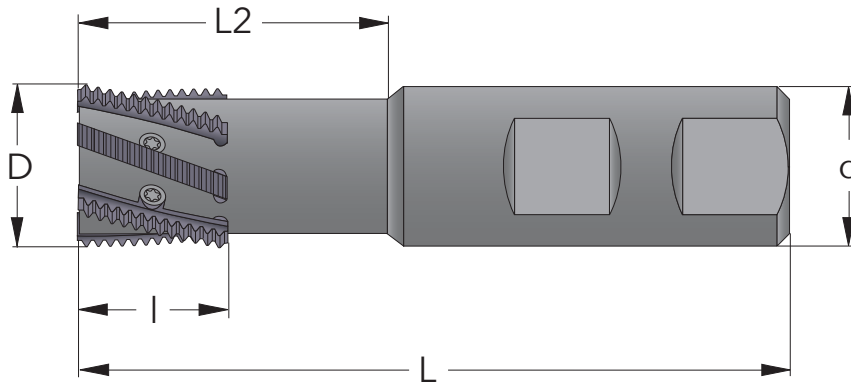

D mm	d mm	Part Number	l mm	L2 mm	L mm	No. of Inserts
23	25	SRH23-2	27	50	110	2
23	25	SRH23M-2	27	75	150	2
32	32	SRH32-5	32	60	130	5
32	32	SRH32P-5	32	90	180	5
45	32	SRH45-6	37	-	130	6



THREAD MILLING CUTTERS

Spiral Fluted Face Mill Cutters

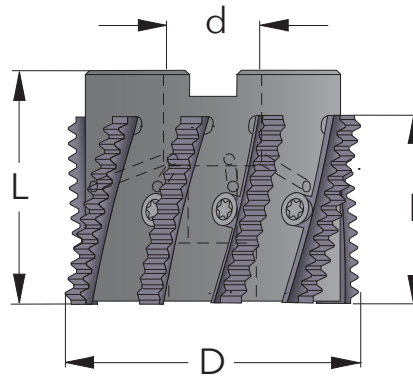

D mm	d mm	Part Number	l mm	L mm	No. of Inserts
32	16	SRH32-5M	32	52	5
45	22	SRH45-6M	37	60	6
63	22	SRH63-9	38	50	9

Spare Parts

Insert mm	Screw to insert	Torx key
H23	S23	K21
H32	S32	K22
H45	S45	K40
H63	S63	K40







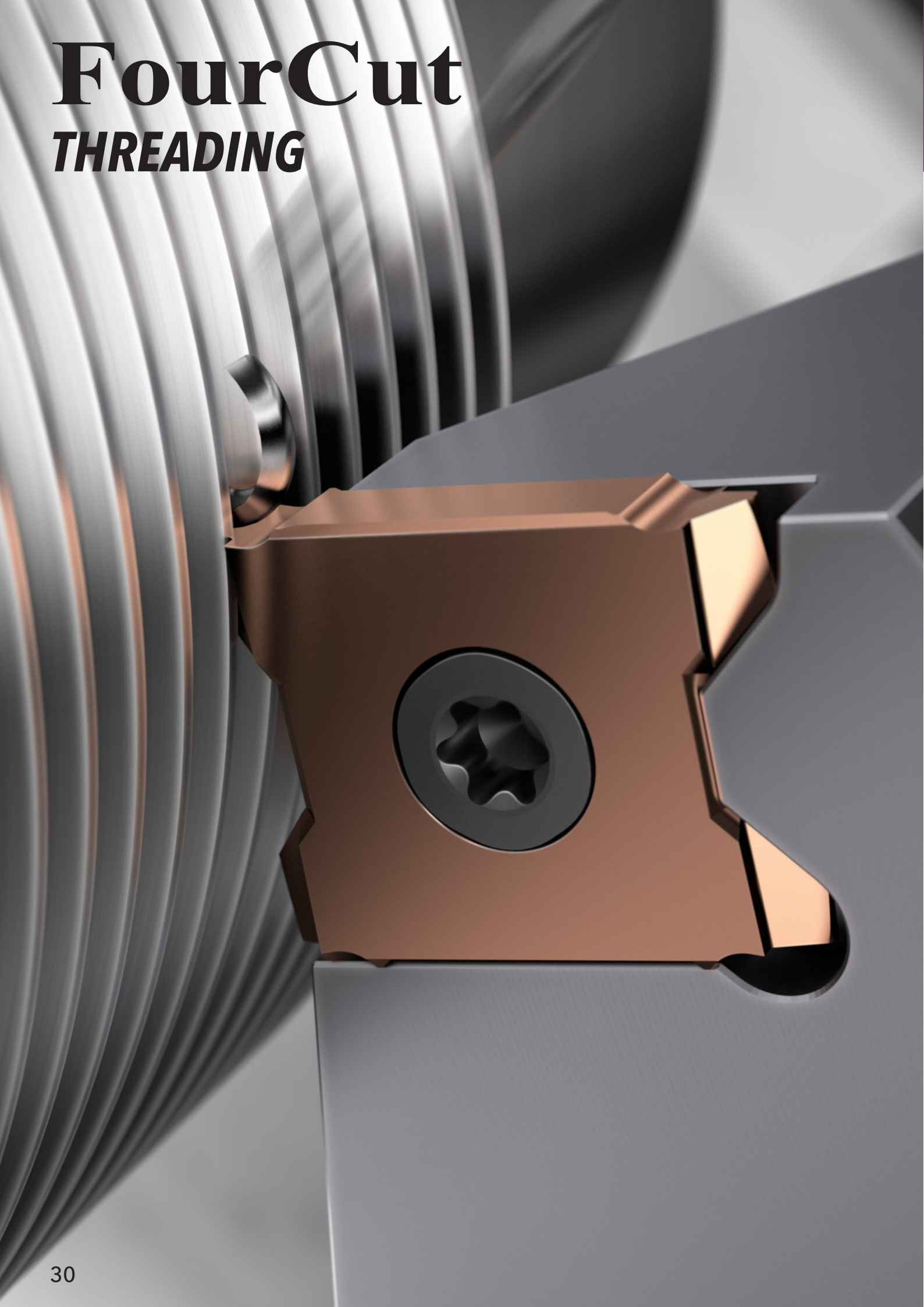





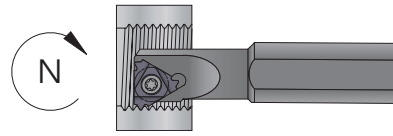

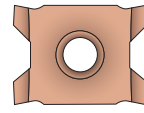

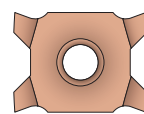

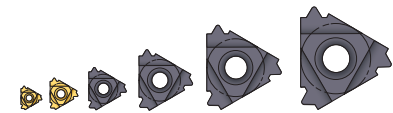
FourCut

THREADING

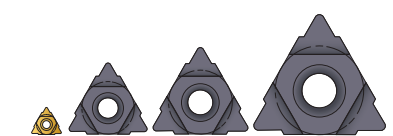

THREAD TURNING

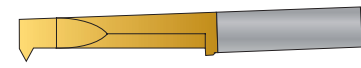
CONTENTS

Technical Information	32	
 FourCut Thread Turning Inserts	40	
External Toolholders	44	
 FourCut Grooving Inserts	46	
 Triangular Thread Turning Inserts	48	
External Toolholders	58	
Internal Toolholders	59	
 U-type Thread Turning Inserts	60	
External Toolholders	62	
Internal Toolholders	63	
 Micro Thread Turning Inserts	64	
Toolholders	65	

Cost-effective

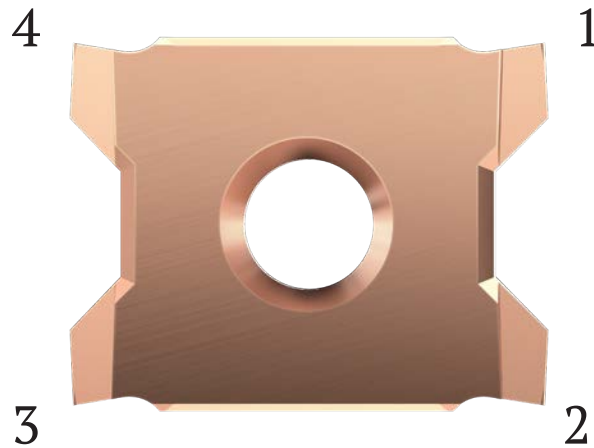

Four Cutting Edges - for the Price of Three

As the price for the inserts are the same, the FourCut threading insert is 25% cheaper as it has four cutting edges instead of three.

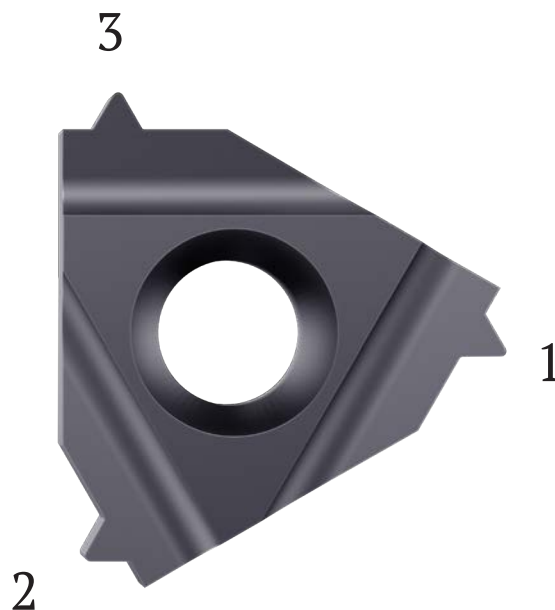

Strength

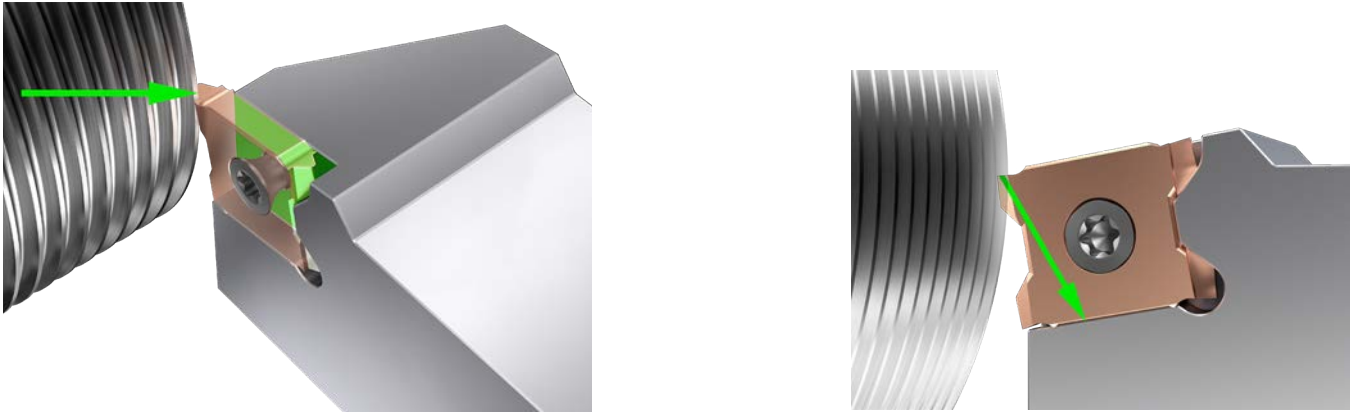

Strong and Stable Machining

FourCut is a vertical insert. This gives a very strong insert. The cutting forces go in to the insert and you don't need any anvil as the carbide insert take up the forces.

No problem with the side forces as the flat surface of the insert take up these forces. No weak point on the toolholder.

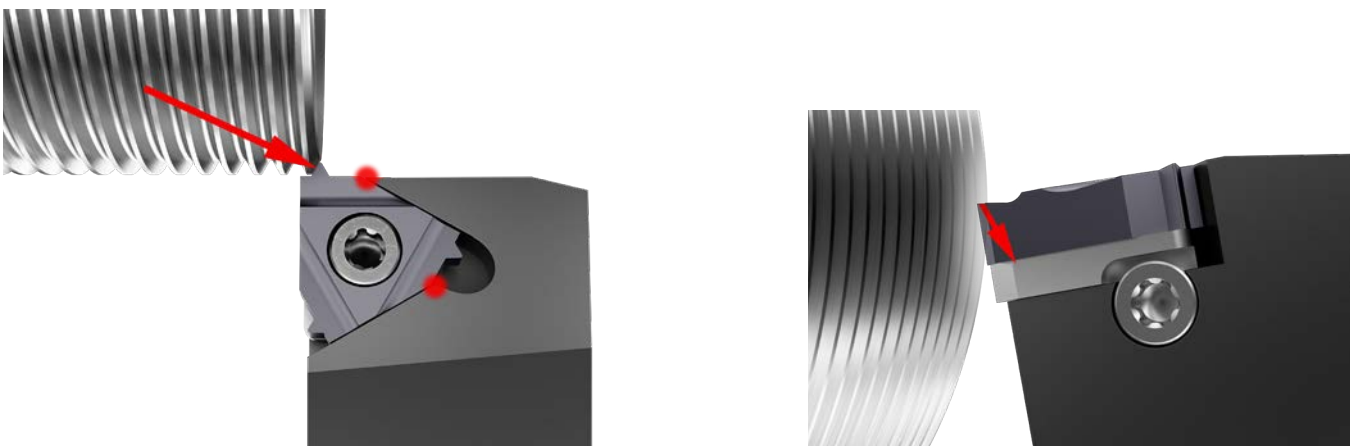

Accessibility

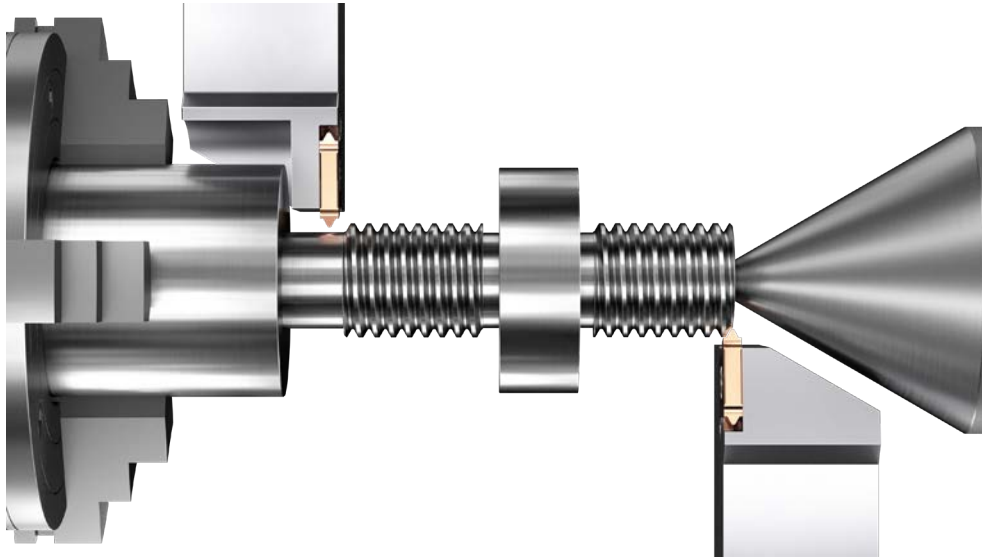

Minimum Waste of Material

With a vertical insert the accessibility gives you two main advantages.

- 1) Less waste of material as you don't need to turn away material to be able to make the thread.
- 2) As you have more space you can use a live center when you are turning small diameters. This will give you a stable machining and a better quality of the thread.

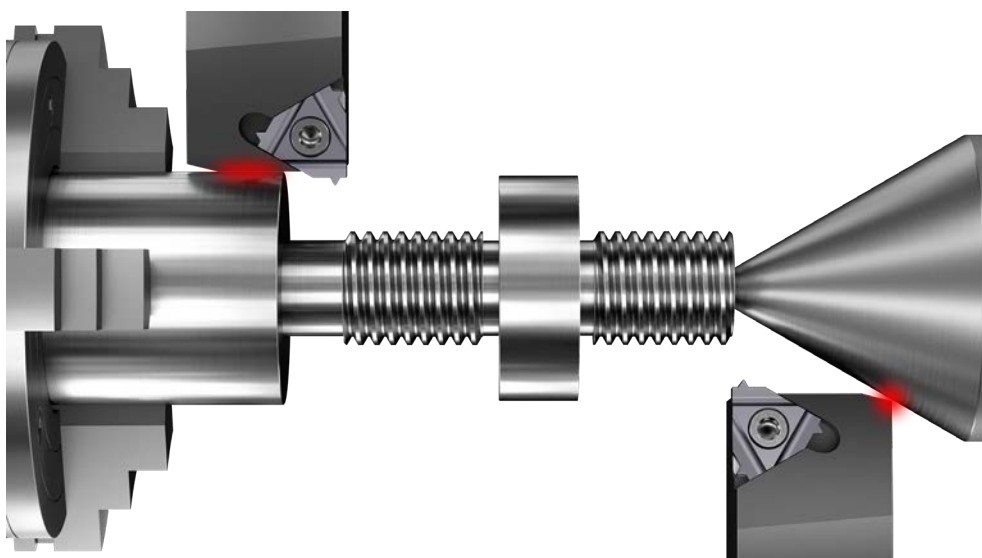

Optimal Clearance

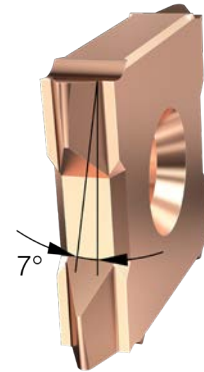
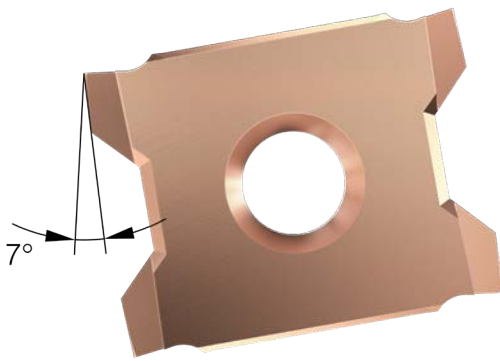

Perfect Cutting Conditions

The inserts are ground on all sides with a complex grinding technology on 6-axis grinding machines to get a 7° clearance angle all around the thread profile which gives the following advantages:

- 1) Extra clearance on the flanks gives better cutting conditions.
- 2) Same toolholder for different helix angles as the extra clearance allow you to have bigger difference in helix angle.
- 3) Less clearance on the radius gives stronger cutting edge and longer tool life.

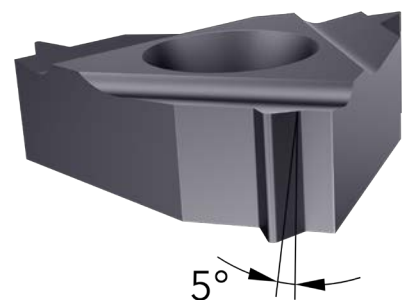
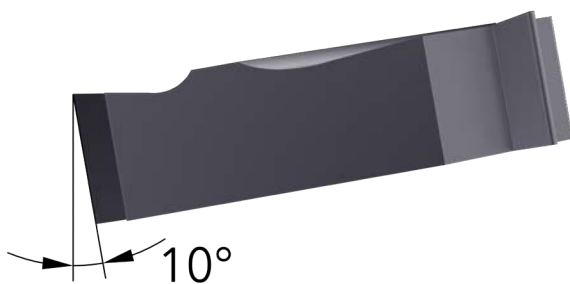

THREAD TURNING INSERTS

Helix Angle

To get good cutting conditions the threading insert has to be inclined into the toolholder at approximately the same angle as the helix angle of the thread.

$$\tan \lambda = \frac{P}{\pi \times D}$$

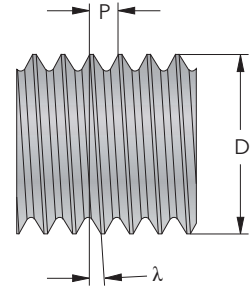

The FourCut inserts has extra clearance on the flanks and therefore it is not so important to have correct helix angle. The standard toolholder has 2° helix angle and it is possible to make almost all threads with the same holder.

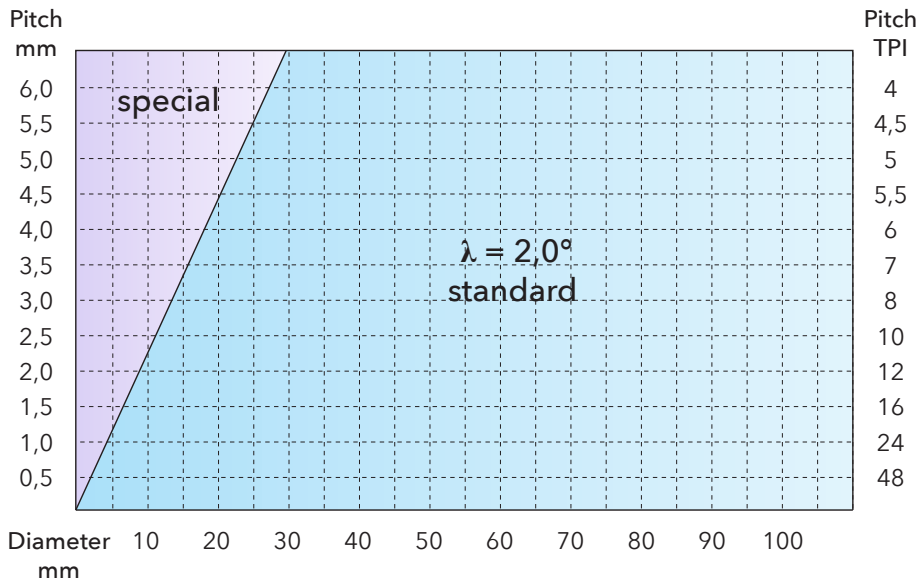

On the triangular inserts it is more important to have a similar helix angle on the toolholder as the thread. The standard toolholder has an anvil which gives 1,5° helix angle. If you need bigger or smaller, you just change the anvil.

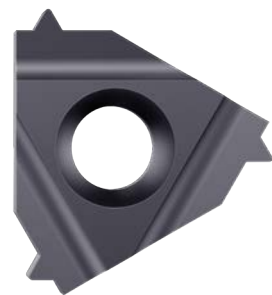
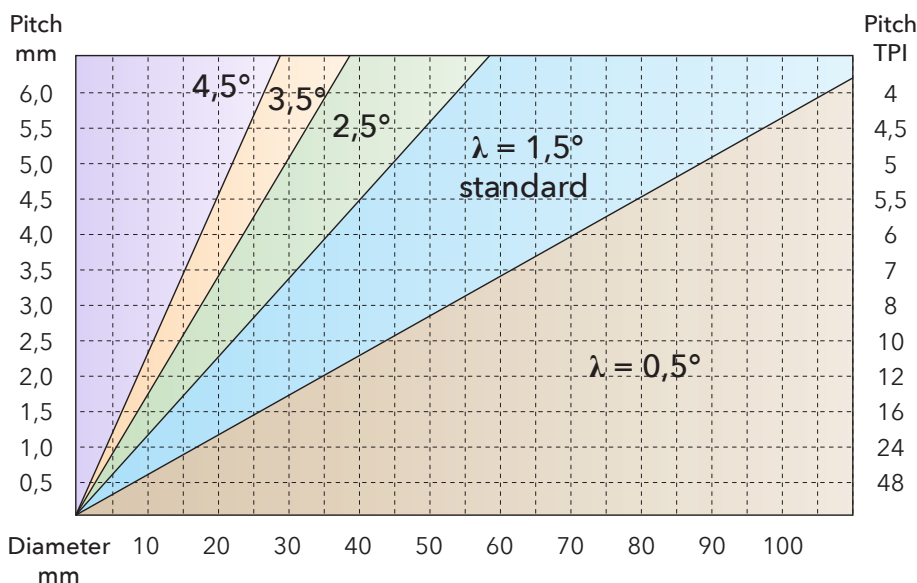

CODE KEY

Inserts

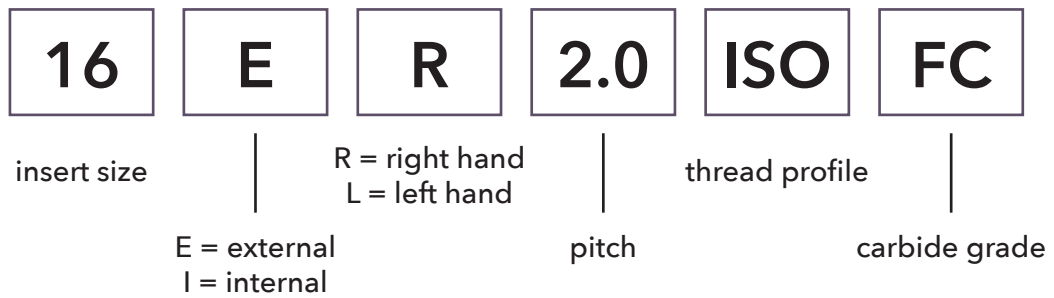



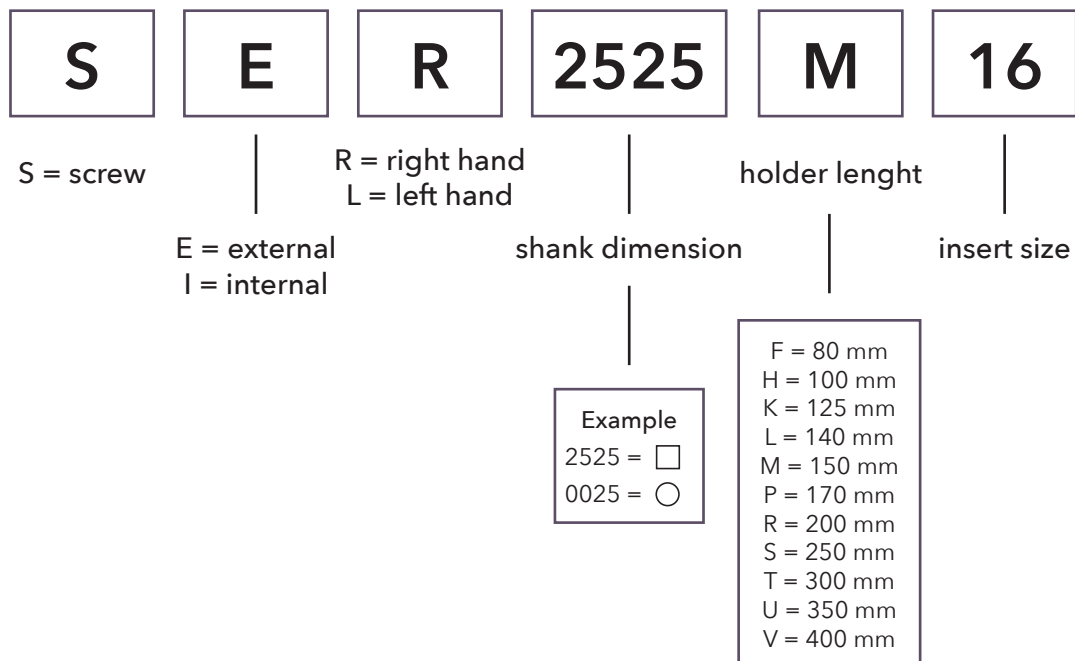





Toolholders











Cutting Speed (V_c) and Material Factor (F_m)

MATERIAL		Hardness HB	Tensile Strength N/mm ²	Cutting Speed (V_c) m/min	Material Factor (F_m)
Steel	Low carbon, C < 0,25%	< 120	< 400	150 - 200	1,2
	Medium carbon, C < 0,55%	< 200	< 700	120 - 170	1,1
	High carbon, C < 0,85%	< 250	< 850	110 - 150	1,0
	Low alloy	< 250	< 850	100 - 140	1,0
	High alloy	< 350	< 1200	70 - 110	0,9
	Hardened, HRC < 45			60 - 100	0,8
	Hardened, HRC < 55			30 - 60	0,7
	Hardened, HRC < 65			20 - 40	0,6
Cast iron	Lamellar graphite	< 150	< 500	130 - 180	1,2
	Lamellar graphite	< 300	< 1000	100 - 150	1,1
	Nodular graphite, malleable	< 200	< 700	100 - 150	1,0
	Nodular graphite, malleable	< 300	< 1000	80 - 120	0,9
Stainless steel	Free machining	< 250	< 850	130 - 180	1,0
	Austenitic	< 250	< 850	90 - 140	0,9
	Ferritic and austenitic	< 300	< 1000	80 - 120	0,8
Titanium	Unalloyed	< 200	< 700	60 - 80	0,8
	Alloyed	< 270	< 900	50 - 70	0,7
	Alloyed	< 350	< 1250	30 - 50	0,6
Nickel	Unalloyed	< 150	< 500	80 - 120	0,8
	Alloyed	< 270	< 900	60 - 80	0,7
	Alloyed	< 350	< 1250	50 - 70	0,6
Copper	Unalloyed	< 100	< 350	150 - 250	1,0
	Brass, bronze	< 200	< 700	130 - 180	1,0
	High strength bronze	< 470	< 1500	60 - 80	0,8
Aluminium	Unalloyed	< 100	< 350	500 - 900	1,4
	Alloyed, Si < 0.5%	< 150	< 500	400 - 800	1,3
	Alloyed, Si < 10%	< 120	< 400	300 - 500	1,2
	Alloyed, Si > 10%	< 120	< 400	200 - 400	1,1
Inconel	718	< 370		50 - 70	0,6
Graphite				300 - 500	1,0

Threading Methods

RIGHT HAND THREAD			
Tool	Anvil	Rotation	Direction
SER	AE +		
SEL	AI -		
SIR	AI +		
SIL	AE -		

LEFT HAND THREAD			
Tool	Anvil	Rotation	Direction
SEL	AI +		
SER	AE -		
SIL	AE +		
SIR	AI -		

Number of Passes

ISO	Pitch			Material Factor (F_m)								
	UN	W	NPT	0,6	0,7	0,8	0,9	1,0	1,1	1,2	1,3	1,4
0,5				7	6	5	4	4	4	4	4	4
0,75	32	28		8	6	6	5	4	4	4	4	4
1,0	28-24	19		8	7	6	6	5	5	4	4	4
1,25	20			9	8	7	6	6	5	5	4	4
1,5	18-16	14		10	9	8	7	6	5	5	5	4
1,75	14			12	10	9	8	7	6	6	5	5
2,0	13-12		27	14	12	11	9	8	8	7	7	6
2,5	11-10	11	18	16	14	13	11	10	9	8	8	7
3,0	9-8		14	18	16	14	12	11	10	9	8	8
3,5	7			20	17	15	13	12	11	10	9	9
4,0	6		11,5	22	19	16	14	13	12	11	10	9
4,5				23	20	17	15	14	12	11	10	10
5,0	5			24	20	18	16	14	13	12	11	10
5,5	4,5		8	25	21	19	17	15	14	13	12	11
6,0	4			27	23	20	18	16	15	13	12	11

Radial Infeed Each Pass

PASS	Percentage of the total infeed																
	4	5	6	7	8	9	10	11	12	13	14	15	16	17	18	19	20
1	33	28	25	22	20	19	18	16	14	12	11	11	11	11	10	10	9
2	27	24	20	18	17	16	15	14	13	11	10	10	10	10	10	9	9
3	22	19	17	16	15	14	13	12	11	10	9	9	9	9	9	8	8
4	18	16	15	14	13	12	11	10	9	9	8	8	8	8	8	8	8
5		13	13	12	11	10	9	8	8	8	8	8	8	8	8	7	7
6			10	10	10	9	8	8	8	8	8	7	7	7	7	6	6
7				8	8	8	7	8	8	7	7	7	7	6	6	6	6
8					6	7	7	7	7	7	7	7	6	6	6	6	6
9						5	7	7	7	7	7	6	6	5	6	5	5
10							5	6	6	6	6	6	5	5	5	5	5
11								4	5	6	6	5	5	5	5	5	5
12									4	5	5	5	5	4	4	5	5
13										4	4	4	4	4	4	4	4
14											3	4	4	4	3	4	4
15												3	3	3	3	4	3
16													2	2	2	3	3
17														2	2	2	2
18															2	1,5	2
19																1,5	1,5
20																	1,5

Carbide Grades

FC

Micrograin Carbide with TiAlN coating.
Allround Grade with high heat resistance.
Use cutting data according to the tables.

BC

Micrograin Carbide with TiN coating.
Suitable for internal thread turning of small dimensions. Cutting speed 40% less than FC.

HC

Micrograin Carbide with AlTiSiN coating.
Allround Grade with high hardness and heat resistance.
Use cutting data according to the tables.

THREAD TURNING INSERTS

FourCut

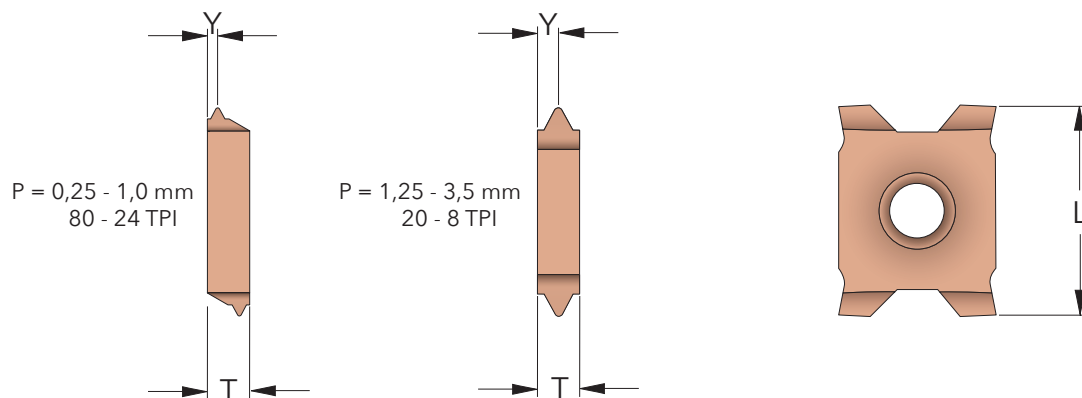

M

METRIC

Pitch mm	Part Number EXTERNAL	L mm	T mm	Y mm
0,25	12E_0.25ISO_HC	12	2,4	0,2
0,3	12E_0.3ISO_HC	12	2,4	0,2
0,35	12E_0.35ISO_HC	12	2,4	0,25
0,4	12E_0.4ISO_HC	12	2,4	0,3
0,45	12E_0.45ISO_HC	12	2,4	0,4
0,5	12E_0.5ISO_HC	12	2,4	0,4
0,6	12E_0.6ISO_HC	12	2,4	0,4
0,7	12E_0.7ISO_HC	12	2,4	0,4
0,75	12E_0.75ISO_HC	12	2,4	0,4
0,8	12E_0.8ISO_HC	12	2,4	0,5
1,0	12E_1.0ISO_HC	12	2,4	0,6
1,25	12E_1.25ISO_HC	12	2,4	1,2
1,5	12E_1.5ISO_HC	12	2,4	1,2
1,75	12E_1.75ISO_HC	12	2,4	1,2
2,0	12E_2.0ISO_HC	12	2,4	1,2
2,5	12E_2.5ISO_HC	12	3,6	1,8
3,0	12E_3.0ISO_HC	12	3,6	1,8
3,5	12E_3.5ISO_HC	12	3,6	1,8

UN

UNIFIED

Pitch TPI	Part Number EXTERNAL	L mm	T mm	Y mm
80	12E_80UN_HC	12	2,4	0,2
72	12E_72UN_HC	12	2,4	0,25
64	12E_64UN_HC	12	2,4	0,3
56	12E_56UN_HC	12	2,4	0,4
48	12E_48UN_HC	12	2,4	0,4
44	12E_44UN_HC	12	2,4	0,4
40	12E_40UN_HC	12	2,4	0,4
36	12E_36UN_HC	12	2,4	0,4
32	12E_32UN_HC	12	2,4	0,5
28	12E_28UN_HC	12	2,4	0,6
24	12E_24UN_HC	12	2,4	0,6
20	12E_20UN_HC	12	2,4	1,2
18	12E_18UN_HC	12	2,4	1,2
16	12E_16UN_HC	12	2,4	1,2
14	12E_14UN_HC	12	2,4	1,2
13	12E_13UN_HC	12	2,4	1,2
12	12E_12UN_HC	12	2,4	1,2
11	12E_11UN_HC	12	3,6	1,8
10	12E_10UN_HC	12	3,6	1,8
9	12E_9UN_HC	12	3,6	1,8
8	12E_8UN_HC	12	3,6	1,8

THREAD TURNING INSERTS



FourCut

60°

PARTIAL PROFILE 60°

Pitch mm	TPI	Part Number EXTERNAL	L mm	T mm	Y mm
0,35 - 1,0	72-24	12E_AA60_HC	12	2,4	0,6
0,5 - 2,0	48-12	12E_A60_HC	12	2,4	1,2
0,5 - 3,0	48-8	12E_AG60_HC	12	3,6	1,8
1,75 - 3,0	14-8	12E_G60_HC	12	3,6	1,8

55°

PARTIAL PROFILE 55°

Pitch mm	TPI	Part Number EXTERNAL	L mm	T mm	Y mm
0,35 - 1,0	72-24	12E_AA55_HC	12	2,4	0,6
0,5 - 2,0	48-12	12E_A55_HC	12	2,4	1,2
0,5 - 3,0	48-8	12E_AG55_HC	12	3,6	1,8
1,75 - 3,0	14-8	12E_G55_HC	12	3,6	1,8

BS/G/Rp

WHITWORTH PIPE THREAD

Pitch TPI	Part Number EXTERNAL	L mm	T mm	Y mm
28	12E_28W_HC	12	2,4	0,6
24	12E_24W_HC	12	2,4	0,6
20	12E_20W_HC	12	2,4	1,2
19	12E_19W_HC	12	2,4	1,2
18	12E_18W_HC	12	2,4	1,2
16	12E_16W_HC	12	2,4	1,2
14	12E_14W_HC	12	2,4	1,2
12	12E_12W_HC	12	2,4	1,2
11	12E_11W_HC	12	3,6	1,8
10	12E_10W_HC	12	3,6	1,8
9	12E_9W_HC	12	3,6	1,8
8	12E_8W_HC	12	3,6	1,8

R/Rc

BSPT PIPE THREAD

Pitch TPI	Part Number EXTERNAL	L mm	T mm	Y mm
28	12E_28BSPT_HC	12	2,4	1,2
19	12E_19BSPT_HC	12	2,4	1,2
14	12E_14BSPT_HC	12	3,6	1,8
11	12E_11BSPT_HC	12	3,6	1,8

NPT

NPT PIPE THREAD

Pitch TPI	Part Number EXTERNAL	L mm	T mm	Y mm
27	12E_27NPT_HC	12	2,4	0,6
18	12E_18NPT_HC	12	2,4	1,2
14	12E_14NPT_HC	12	2,4	1,2
11,5	12E_11.5NPT_HC	12	3,6	1,8
8	12E_8NPT_HC	12	3,6	1,8

NPTF

NPTF DRYSEAL PIPE THREAD

Pitch TPI	Part Number EXTERNAL	L mm	T mm	Y mm
27	12E_27NPTF_HC	12	2,4	0,6
18	12E_18NPTF_HC	12	2,4	1,2
14	12E_14NPTF_HC	12	2,4	1,2
11,5	12E_11.5NPTF_HC	12	3,6	1,8
8	12E_8NPTF_HC	12	3,6	1,8

■ All inserts have ground profile and chipbreaker.

THREAD TURNING INSERTS

FourCut

PG

STEEL CONDUIT THREAD DIN 40430

Pitch TPI	Part Number EXTERNAL	L mm	T mm	Y mm
20	12E_20PG_HC	12	2,4	1,2
18	12E_18PG_HC	12	2,4	1,2
16	12E_16PG_HC	12	2,4	1,2

TR

TRAPEZ DIN 103

Pitch mm	Part Number EXTERNAL	L mm	T mm	Y mm
1,5	12E_1.5TR_HC	12	2,4	1,2
2,0	12E_2.0TR_HC	12	2,4	1,2
3,0	12E_3.0TR_HC	12	2,4	1,2
4,0	12E_4.0TR_HC	12	3,6	1,8

RD

ROUND DIN 405

Pitch TPI	Part Number EXTERNAL	L mm	T mm	Y mm
10	12E_10RD_HC	12	3,6	1,8
8	12E_8RD_HC	12	3,6	1,8

ACME

ACME

Pitch TPI	Part Number EXTERNAL	L mm	T mm	Y mm
16	12E_16ACME_HC	12	2,4	1,2
14	12E_14ACME_HC	12	2,4	1,2
12	12E_12ACME_HC	12	2,4	1,2
10	12E_10ACME_HC	12	2,4	1,2
8	12E_8ACME_HC	12	2,4	1,2
6	12E_6ACME_HC	12	3,6	1,8

STACME

STUB ACME

Pitch TPI	Part Number EXTERNAL	L mm	T mm	Y mm
16	12E_16STACME_HC	12	2,4	1,2
14	12E_14STACME_HC	12	2,4	1,2
12	12E_12STACME_HC	12	2,4	1,2
10	12E_10STACME_HC	12	2,4	1,2
8	12E_8STACME_HC	12	2,4	1,2
6	12E_6STACME_HC	12	3,6	1,8
5	12E_5STACME_HC	12	3,6	1,8

MJ

METRIC

Pitch mm	Part Number EXTERNAL	L mm	T mm	Y mm
1,0	12E_1.0MJ_HC	12	2,4	0,6
1,5	12E_1.5MJ_HC	12	2,4	1,2
2,0	12E_2.0MJ_HC	12	3,6	1,8

■ All inserts have ground profile and chipbreaker.

THREAD TURNING INSERTS



FourCut Multitooth

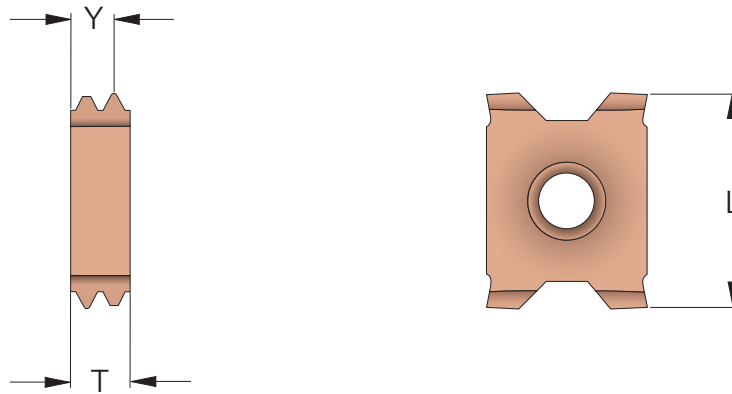

M

METRIC

Pitch mm	Part Number EXTERNAL	L mm	T mm	Y mm	Radial infeed per pass		
					1	2	3
1,0	12ER_1.0ISO2M_HC	12	2,4	1,7	0,24	0,21	0,18
1,5	12ER_1.5ISO2M_HC	12	3,6	2,55	0,43	0,30	0,21
2,0	12ER_2.0ISO2M_HC	12	3,6	2,8	0,57	0,40	0,28

G/Rp

WHITWORTH PIPE THREAD

Pitch TPI	Part Number EXTERNAL	L mm	T mm	Y mm	Radial infeed per pass		
					1	2	3
14	12ER_14W2M_HC	12	3,6	2,7	0,55	0,38	0,25

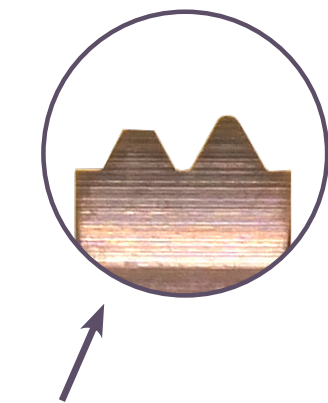

Advantages with Multitooth Inserts

With multitooth inserts the machining time can be reduced about 50% as two cutting edges are working every pass.

The first edge will cut the flanks of the thread and the second one will make the root radius. This will result in three easy breakable chips.

It is important to use radial infeed to get best performance. Above you have recommended infeed per pass for each insert.

Threading Inserts Kits

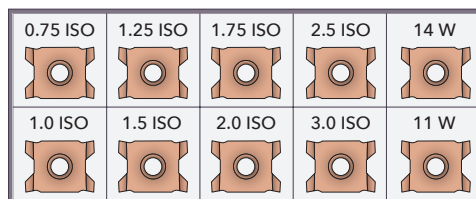

Part Number

10X12E_HC

■ 10 different inserts in one box.

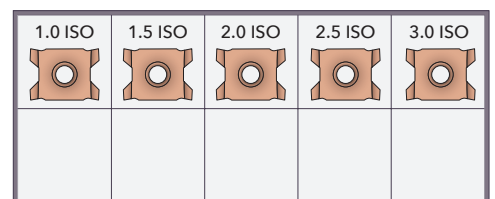

Part Number

5X12E_HC

■ 5 different inserts in one box.

THREAD TURNING TOOLHOLDERS

FourCut External

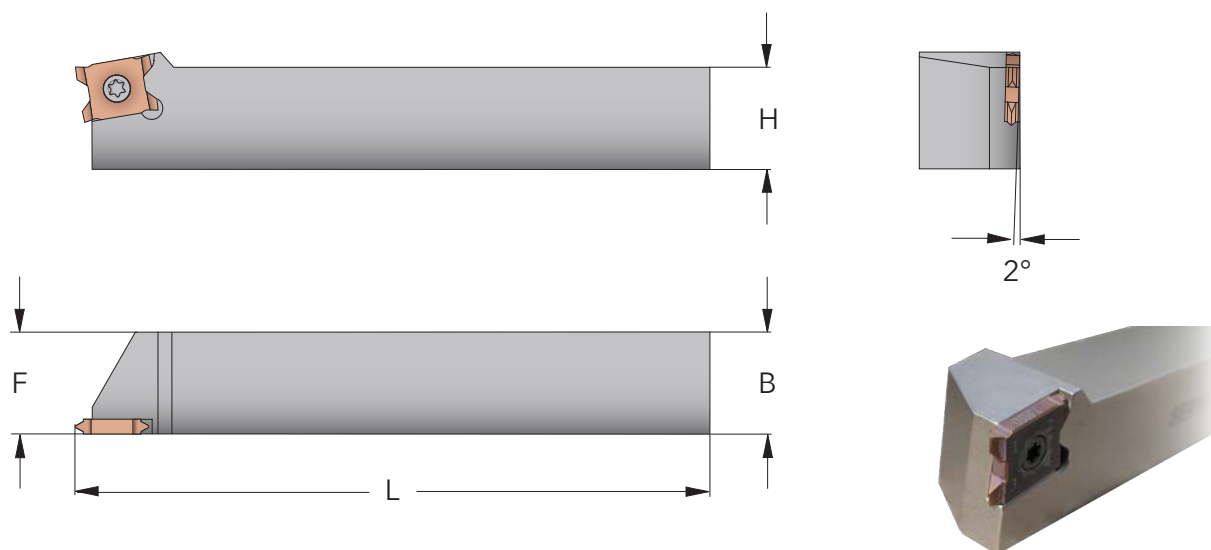

Insert mm	Part Number	B/H mm	L mm	F mm
12	SER0808H12	8	100	8
12	SER1010H12	10	100	10
12	SER1212H12	12	100	12
12	SER1616H12	16	100	16
12	SER2020K12	20	125	20
12	SER2525M12	25	150	25
12	SER3232P12	32	170	32

■ The Part Numbers are for Right Hand Toolholders. For Left Hand specify L instead of R. The Price is 10% higher for L.

with Internal Coolant

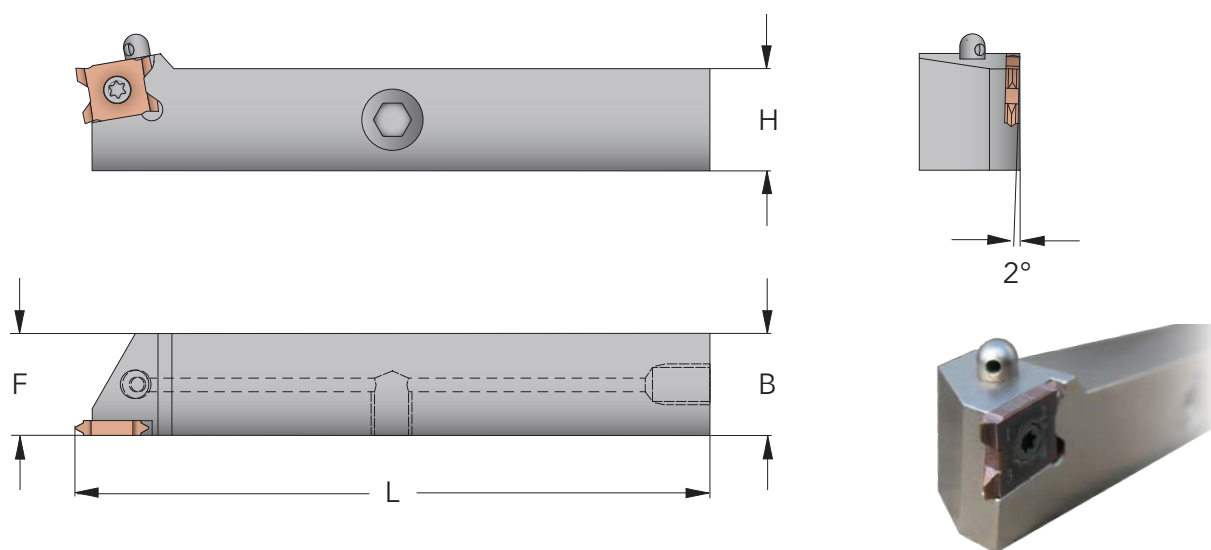

Insert mm	Part Number	B/H mm	L mm	F mm	PLUG
12	SER1212H12-J*	12	100	12	M8x1
12	SER1616H12-J	16	100	16	G1/8
12	SER2020K12-J	20	125	20	G1/8
12	SER2525M12-J	25	150	25	G1/8

* This toolholder also has a plug on the backside, totally three plugs.

THREAD TURNING TOOLHOLDERS

with Extra Accessibility

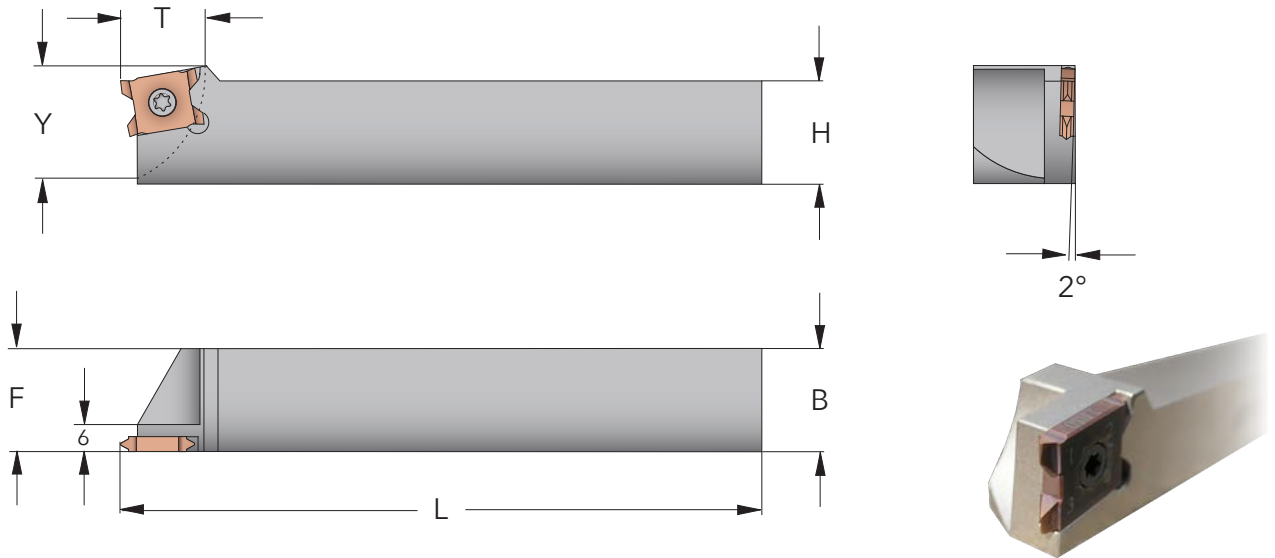

Insert mm	Part Number	B/H mm	L mm	F mm	T mm	Y mm
12	SER1212T09H12	12	100	12	9	11,0
12	SER1616T11H12	16	100	16	11	14,7
12	SER2020T14K12	20	125	20	14	18,7
12	SER2525T18M12	25	150	25	18	23,8

Maximum Allowable Access

When you are working between shoulders there is a limit of the accessibility which depends on the toolholder and the diameters of the workpiece.

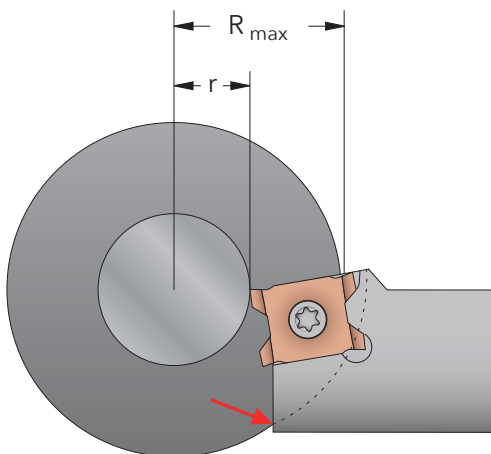

$$R_{\max} = \sqrt{(r + 2,5)^2 + Y^2}$$

$$T = R - r$$

You should never exceed the calculated R_{\max} or the T dimension of the toolholder. If you need better accessibility you have to modify the holder.

For diagram of accessibility go to smicut.com/acc

Spare Parts

Insert mm	Screw to insert	Torx key
12	T9XM3	TORX_T9

GROOVING INSERTS

FourCut

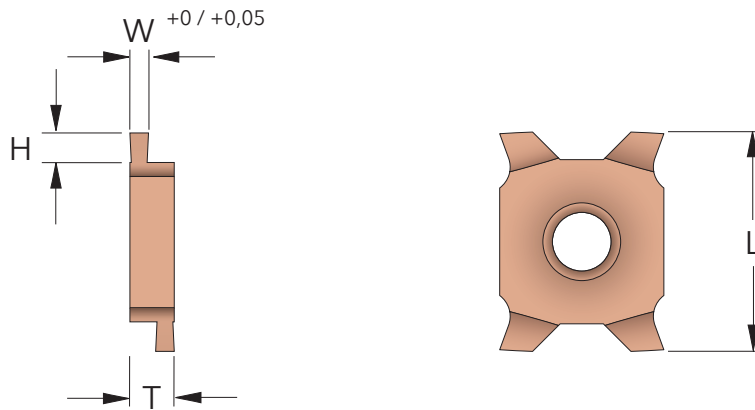

SQ

GROOVING

W +0 / +0,05	EXTERNAL Part Number	L mm	T mm	H mm
0,4	12ER_0.4SQ_HC	12	2,4	0,8
0,5	12ER_0.5SQ_HC	12	2,4	1,0
0,6	12ER_0.6SQ_HC	12	2,4	1,2
0,7	12ER_0.7SQ_HC	12	2,4	1,4
0,8	12ER_0.8SQ_HC	12	2,4	1,6
0,9	12ER_0.9SQ_HC	12	2,4	1,8
1,0	12ER_1.0SQ_HC	12	2,4	2,0
1,1	12ER_1.1SQ_HC	12	2,4	2,0
1,2	12ER_1.2SQ_HC	12	2,4	2,0
1,3	12ER_1.3SQ_HC	12	2,4	2,0
1,4	12ER_1.4SQ_HC	12	2,4	2,0
1,5	12ER_1.5SQ_HC	12	2,4	2,0
1,6	12ER_1.6SQ_HC	12	2,4	2,0
1,7	12ER_1.7SQ_HC	12	2,4	2,0
1,85	12ER_1.85SQ_HC	12	2,4	2,0
2,0	12ER_2.0SQ_HC	12	2,4	2,0
2,15	12ER_2.15SQ_HC	12	2,4	2,0
2,3	12ER_2.3SQ_HC	12	2,4	2,0
2,5	12ER_2.5SQ_HC	12	3,6	2,0
2,65	12ER_2.65SQ_HC	12	3,6	2,0
2,8	12ER_2.8SQ_HC	12	3,6	2,0
3	12ER_3.0SQ_HC	12	3,6	2,0
3,15	12ER_3.15SQ_HC	12	3,6	2,0
3,3	12ER_3.3SQ_HC	12	3,6	2,0
3,5	12ER_3.5SQ_HC	12	3,6	2,0

Grooving Inserts Kit

Maximum Grooving Diameter

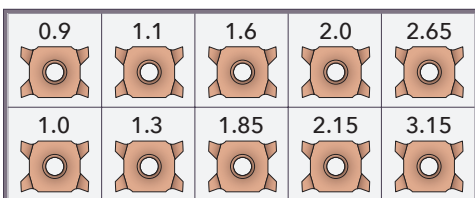

Part Number
10X12SQ_HC

10 different inserts in one box

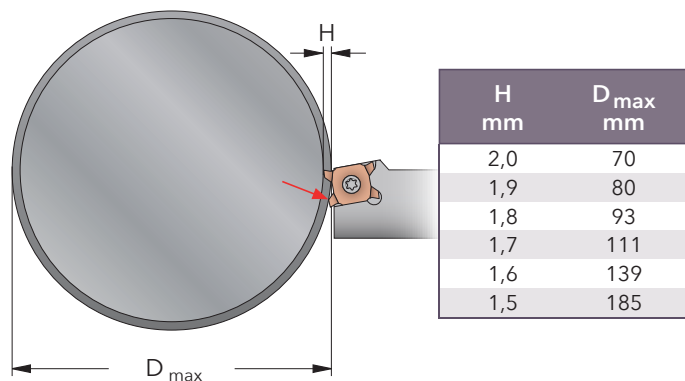

You are not able to use the maximum grooving depth when the diameter is bigger than D_{max} as the cutting edge below will touch the part.

A close-up photograph of a metal cutting tool, specifically a FourCut toolholder, in the process of cutting a groove into a metal workpiece. The toolholder is a complex, multi-faceted metal piece with a central circular hole containing a cutting insert. The workpiece is a cylindrical metal rod. The background is a soft, out-of-focus grey.

FourCut

GROOVING

**Same toolholder for
GROOVING and THREADING!**

THREAD TURNING INSERTS

Triangular

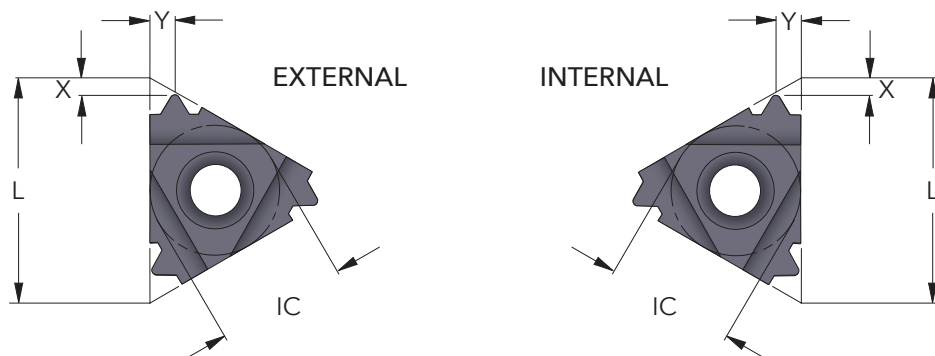

M

METRIC

Pitch mm	L mm	IC inch	EXTERNAL Part Number	X mm	Y mm	INTERNAL Part Number	X mm	Y mm
0,5	6	5/32				06IR_0.5ISO_BC	0,9	0,5
0,5	16	3/8	16ER_0.5ISO_FC	0,6	0,6			
0,7	16	3/8	16ER_0.7ISO_FC	0,6	0,6			
0,75	6	5/32				06IR_0.75ISO_BC	0,8	0,5
0,75	8	3/16				08IR_0.75ISO_BC	0,6	0,5
0,75	16	3/8	16ER_0.75ISO_FC	0,6	0,6			
0,8	16	3/8	16ER_0.8ISO_FC	0,6	0,6			
1,0	6	5/32				06IR_1.0ISO_BC	0,7	0,6
1,0	8	3/16				08IR_1.0ISO_BC	0,6	0,6
1,0	11	1/4				11IR_1.0ISO_FC	0,6	0,7
1,0	16	3/8	16ER_1.0ISO_FC	0,7	0,7	16IR_1.0ISO_FC	0,6	0,7
1,25	6	5/32				06IR_1.25ISO_BC	0,6	0,6
1,25	8	3/16				08IR_1.25ISO_BC	0,6	0,7
1,25	11	1/4				11IR_1.25ISO_FC	0,8	0,8
1,25	16	3/8	16ER_1.25ISO_FC	0,8	0,9	16IR_1.25ISO_FC	0,8	0,9
1,5	8	3/16				08IR_1.5ISO_BC	0,6	0,7
1,5	11	1/4				11IR_1.5ISO_FC	0,8	1,0
1,5	16	3/8	16ER_1.5ISO_FC	0,8	1,0	16IR_1.5ISO_FC	0,8	1,0
1,75	8	3/16				08IR_1.75ISO_BC	1,0	0,8
1,75	16	3/8	16ER_1.75ISO_FC	0,9	1,2			
2,0	11	1/4				11IR_2.0ISO_FC	0,8	0,9
2,0	16	3/8	16ER_2.0ISO_FC	1,0	1,3	16IR_2.0ISO_FC	1,0	1,3
2,5	16	3/8	16ER_2.5ISO_FC	1,1	1,5	16IR_2.5ISO_FC	1,1	1,5
3,0	16	3/8	16ER_3.0ISO_FC	1,2	1,6	16IR_3.0ISO_FC	1,1	1,5
3,5	16	3/8	16ER_3.5ISO_FC	1,2	1,7	16IR_3.5ISO_FC	1,2	1,7
3,5	22	1/2	22ER_3.5ISO_FC	1,6	2,3	22IR_3.5ISO_FC	1,6	2,3
4,0	22	1/2	22ER_4.0ISO_FC	1,6	2,3	22IR_4.0ISO_FC	1,6	2,3
4,5	22	1/2	22ER_4.5ISO_FC	1,7	2,4	22IR_4.5ISO_FC	1,6	2,4
5,0	22	1/2	22ER_5.0ISO_FC	1,7	2,5	22IR_5.0ISO_FC	1,6	2,3
5,5	22	1/2	22ER_5.5ISO_FC	1,7	2,6	22IR_5.5ISO_FC	1,6	2,3
5,5	27	5/8	27ER_5.5ISO_FC	1,9	2,7	27IR_5.5ISO_FC	1,6	2,3
6,0	22	1/2	22ER_6.0ISO_FC	1,9	2,7	22IR_6.0ISO_FC	1,6	2,4
6,0	27	5/8	27ER_6.0ISO_FC	2,0	2,9	27IR_6.0ISO_FC	1,8	2,5
WITH SINTERED CHIPBREAKER								
1,0	16	3/8	16ER_1.0ISO CB_FC	0,7	0,7	16IR_1.0ISO CB_FC	0,6	0,7
1,25	16	3/8	16ER_1.25ISO CB_FC	0,8	0,9			
1,5	16	3/8	16ER_1.5ISO CB_FC	0,8	1,0	16IR_1.5ISO CB_FC	0,8	1,0
1,75	16	3/8	16ER_1.75ISO CB_FC	0,9	1,2			
2,0	16	3/8	16ER_2.0ISO CB_FC	1,0	1,3	16IR_2.0ISO CB_FC	1,0	1,3
2,5	16	3/8	16ER_2.5ISO CB_FC	1,1	1,5	16IR_2.5ISO CB_FC	1,1	1,5
3,0	16	3/8	16ER_3.0ISO CB_FC	1,2	1,6	16IR_3.0ISO CB_FC	1,1	1,5

THREAD TURNING INSERTS

UN

UNIFIED

Pitch TPI	L mm	IC inch	EXTERNAL Part Number	X mm	Y mm	INTERNAL Part Number	X mm	Y mm
32	6	5/32				06IR_32UN_BC	0,8	0,5
32	8	3/16				08IR_32UN_BC	0,6	0,5
32	11	1/4				11IR_32UN_FC	0,6	0,6
32	16	3/8	16ER_32UN_FC	0,6	0,6	16IR_32UN_FC	0,6	0,6
28	6	5/32				06IR_28UN_BC	0,8	0,6
28	8	3/16				08IR_28UN_BC	0,6	0,6
28	11	1/4				11IR_28UN_FC	0,6	0,7
28	16	3/8	16ER_28UN_FC	0,6	0,7	16IR_28UN_FC	0,6	0,7
24	6	5/32				06IR_24UN_BC	0,7	0,6
24	8	3/16				08IR_24UN_BC	0,6	0,6
24	11	1/4				11IR_24UN_FC	0,7	0,8
24	16	3/8	16ER_24UN_FC	0,7	0,8			
20	6	5/32				06IR_20UN_BC	0,6	0,6
20	8	3/16				08IR_20UN_BC	0,6	0,7
20	11	1/4				11IR_20UN_FC	0,8	0,9
20	16	3/8	16ER_20UN_FC	0,8	0,9	16IR_20UN_FC	0,8	0,9
18	6	5/32				06IR_18UN_BC	0,6	0,7
18	11	1/4				11IR_18UN_FC	0,8	1,0
18	16	3/8	16ER_18UN_FC	0,8	1,0			
16	8	3/16				08IR_16UN_BC	0,6	0,7
16	11	1/4				11IR_16UN_FC	0,9	1,1
16	16	3/8	16ER_16UN_FC	0,9	1,1	16IR_16UN_FC	0,9	1,1
14	8	3/16				08IR_14UN_BC	0,6	0,8
14	16	3/8	16ER_14UN_FC	1,0	1,2	16IR_14UN_FC	0,9	1,2
13	16	3/8	16ER_13UN_FC	1,0	1,3			
12	11	1/4				11IR_12UN_FC	0,9	1,1
12	16	3/8	16ER_12UN_FC	1,1	1,4	16IR_12UN_FC	1,1	1,4
11	11	1/4				11IR_11UN_FC	0,8	1,1
11	16	3/8	16ER_11UN_FC	1,1	1,5			
10	16	3/8	16ER_10UN_FC	1,1	1,5	16IR_10UN_FC	1,1	1,5
9	16	3/8	16ER_9UN_FC	1,2	1,7	16IR_9UN_FC	1,2	1,7
8	16	3/8	16ER_8UN_FC	1,2	1,6	16IR_8UN_FC	1,1	1,5
7	22	1/2	22ER_7UN_FC	1,6	2,3	22IR_7UN_FC	1,6	2,3
6	22	1/2	22ER_6UN_FC	1,6	2,3	22IR_6UN_FC	1,6	2,3
5	22	1/2	22ER_5UN_FC	1,7	2,5	22IR_5UN_FC	1,6	2,3
4,5	27	5/8	27ER_4.5UN_FC	1,9	2,7	27IR_4.5UN_FC	1,7	2,4
4	27	5/8	27ER_4UN_FC	2,1	3,0	27IR_4UN_FC	1,8	2,7

- The Part Numbers are for Right Hand Inserts. For Left Hand specify L instead of R. The Price is 10% higher for L.
- All inserts have ground profile and chipbreaker if nothing else is indicated.

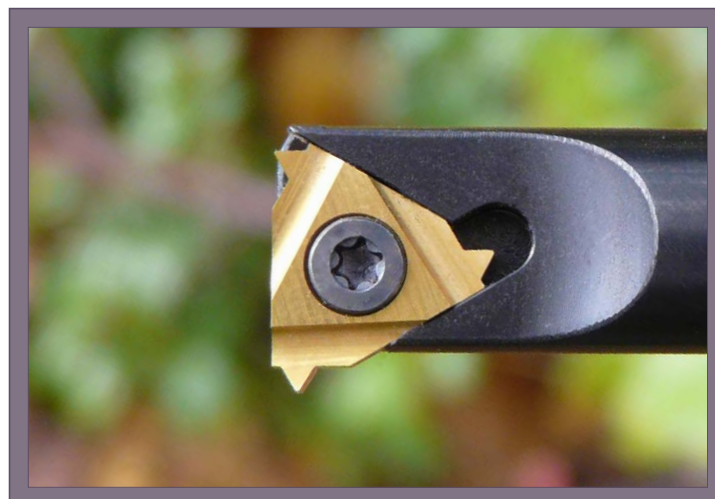

THREAD TURNING INSERTS

60°

PARTIAL PROFILE 60°

Pitch mm	TPI	L mm	IC inch	EXTERNAL Part Number	INTERNAL Part Number	X mm	Y mm
0,5-1,25	48-20	6	5/32		06IR_A60_BC	0,6	0,6
0,5-1,5	48-16	8	3/16		08IR_A60_BC	0,6	0,7
0,5-1,5	48-16	11	1/4		11IR_A60_FC	0,8	0,9
0,5-1,5	48-16	16	3/8	16ER_A60_FC	16IR_A60_FC	0,8	0,9
1,75-3,0	14-8	16	3/8	16ER_G60_FC	16IR_G60_FC	1,2	1,7
0,5-3,0	48-8	16	3/8	16ER_AG60_FC	16IR_AG60_FC	1,2	1,7
3,5-5,0	7-5	22	1/2	22ER_N60_FC	22IR_N60_FC	1,7	2,5
5,5-6,0	4,5-4	27	5/8	27ER_Q60_FC	27IR_Q60_FC	2,1	3,1

55°

PARTIAL PROFILE 55°

Pitch mm	TPI	L mm	IC inch	EXTERNAL Part Number	INTERNAL Part Number	X mm	Y mm
0,5-1,25	48-20	6	5/32		06IR_A55_BC	0,5	0,6
0,5-1,5	48-16	8	3/16		08IR_A55_BC	0,6	0,7
0,5-1,5	48-16	11	1/4		11IR_A55_FC	0,8	0,9
0,5-1,5	48-16	16	3/8	16ER_A55_FC	16IR_A55_FC	0,8	0,9
1,75-3,0	14-8	16	3/8	16ER_G55_FC	16IR_G55_FC	1,2	1,7
0,5-3,0	48-8	16	3/8	16ER_AG55_FC	16IR_AG55_FC	1,2	1,7
3,5-5,0	7-5	22	1/2	22ER_N55_FC	22IR_N55_FC	1,7	2,5
5,5-6,0	4,5-4	27	5/8	27ER_Q55_FC	27IR_Q55_FC	2,0	2,9

MJ

METRIC

Pitch mm	L mm	IC inch	EXTERNAL Part Number	X mm	Y mm	INTERNAL Part Number	X mm	Y mm
1,0	11	1/4				11IR_1.0MJ_FC	0,6	0,7
1,0	16	3/8	16ER_1.0MJ_FC	0,7	0,7	16IR_1.0MJ_FC	0,6	0,7
1,25	11	1/4				11IR_1.25MJ_FC	0,8	0,8
1,25	16	3/8	16ER_1.25MJ_FC	0,8	0,9	16IR_1.25MJ_FC	0,8	0,9
1,5	11	1/4				11IR_1.5MJ_FC	0,8	1,0
1,5	16	3/8	16ER_1.5MJ_FC	0,8	1,0	16IR_1.5MJ_FC	0,8	1,0
2,0	11	1/4				11IR_2.0MJ_FC	0,8	0,9
2,0	16	3/8	16ER_2.0MJ_FC	1,0	1,3	16IR_2.0MJ_FC	1,0	1,3

UNJ

UNIFIED

Pitch TPI	L mm	IC inch	EXTERNAL Part Number	X mm	Y mm	INTERNAL Part Number	X mm	Y mm
32	11	1/4				11IR_32UNJ_FC	0,6	0,6
32	16	3/8	16ER_32UNJ_FC	0,6	0,6	16IR_32UNJ_FC	0,6	0,6
28	11	1/4				11IR_28UNJ_FC	0,6	0,7
28	16	3/8	16ER_28UNJ_FC	0,6	0,7	16IR_28UNJ_FC	0,6	0,7
24	11	1/4				11IR_24UNJ_FC	0,7	0,8
24	16	3/8	16ER_24UNJ_FC	0,7	0,8			
20	11	1/4				11IR_20UNJ_FC	0,8	0,9
20	16	3/8	16ER_20UNJ_FC	0,8	0,9	16IR_20UNJ_FC	0,8	0,9
18	11	1/4				11IR_18UNJ_FC	0,8	1,0
18	16	3/8	16ER_18UNJ_FC	0,8	1,0			
16	11	1/4				11IR_16UNJ_FC	0,9	1,1
16	16	3/8	16ER_16UNJ_FC	0,9	1,1	16IR_16UNJ_FC	0,9	1,1
14	16	3/8	16ER_14UNJ_FC	1,0	1,2	16IR_14UNJ_FC	0,9	1,2
13	16	3/8	16ER_13UNJ_FC	1,0	1,3			
12	16	3/8	16ER_12UNJ_FC	1,1	1,4	16IR_12UNJ_FC	1,1	1,4
11	16	3/8	16ER_11UNJ_FC	1,1	1,5			
10	16	3/8	16ER_10UNJ_FC	1,1	1,5	16IR_10UNJ_FC	1,1	1,5
9	16	3/8	16ER_9UNJ_FC	1,2	1,7	16IR_9UNJ_FC	1,2	1,7
8	16	3/8	16ER_8UNJ_FC	1,2	1,6	16IR_8UNJ_FC	1,1	1,5

THREAD TURNING INSERTS



BS/G/Rp

WHITWORTH

Pitch TPI	L mm	IC inch	EXTERNAL Part Number	X mm	Y mm	INTERNAL Part Number	X mm	Y mm
32	16	3/8	16ER_32W_FC	0,6	0,6			
28	6	5/32				06IR_28W_BC	0,6	0,6
28	8	3/16				08IR_28W_BC	0,6	0,6
28	16	3/8	16ER_28W_FC	0,6	0,7			
26	6	5/32				06IR_26W_BC	0,7	0,6
26	16	3/8	16ER_26W_FC	0,7	0,7			
24	16	3/8	16ER_24W_FC	0,7	0,8			
22	06	5/32				06IR_22W_BC	0,6	0,6
22	16	3/8	16ER_22W_FC	0,8	0,9			
20	08	3/16				08IR_20W_BC	0,6	0,7
20	16	3/8	16ER_20W_FC	0,8	0,9	16IR_20W_FC	0,8	0,9
19	8	3/16				08IR_19W_BC	0,6	0,7
19	11	1/4				11IR_19W_FC	0,8	1,0
19	16	3/8	16ER_19W_FC	0,8	1,0	16IR_19W_FC	0,8	1,0
18	08	3/16				08IR_18W_BC	0,6	0,7
18	16	3/8	16ER_18W_FC	0,8	1,0	16IR_18W_FC	0,8	1,0
16	08	3/16				08IR_16W_BC	0,6	0,7
16	16	3/8	16ER_16W_FC	0,9	1,1	16IR_16W_FC	0,9	1,1
14	11	1/4				11IR_14W_FC	0,9	1,1
14	16	3/8	16ER_14W_FC	1,0	1,2	16IR_14W_FC	1,0	1,2
12	11	1/4				11IR_12W_FC	0,1	1,1
12	16	3/8	16ER_12W_FC	1,1	1,4	16IR_12W_FC	1,1	1,4
11	16	3/8	16ER_11W_FC	1,1	1,5	16IR_11W_FC	1,1	1,5
10	16	3/8	16ER_10W_FC	1,1	1,5	16IR_10W_FC	1,1	1,5
9	16	3/8	16ER_9W_FC	1,2	1,7	16IR_9W_FC	1,2	1,7
8	16	3/8	16ER_8W_FC	1,2	1,5	16IR_8W_FC	1,2	1,5
7	22	1/2	22ER_7W_FC	1,6	2,3	22IR_7W_FC	1,6	2,3
6	22	1/2	22ER_6W_FC	1,6	2,3	22IR_6W_FC	1,6	2,3
5	22	1/2	22ER_5W_FC	1,7	2,4	22IR_5W_FC	1,7	2,4
4,5	27	5/8	27ER_4.5W_FC	1,8	2,6	27IR_4.5W_FC	1,8	2,6
4	27	5/8	27ER_4W_FC	2,0	2,9	27IR_4W_FC	2,0	2,9
WITH SINTERED CHIPBREAKER								
19	16	3/8	16ER_19WCB_FC	0,8	1,0			
14	16	3/8	16ER_14WCB_FC	1,0	1,2	16IR_14WCB_FC	1,0	1,2
11	16	3/8	16ER_11WCB_FC	1,1	1,5	16IR_11WCB_FC	1,1	1,5

R/Rc

BSPT PIPE THREAD

Pitch TPI	L mm	IC inch	EXTERNAL Part Number	X mm	Y mm	INTERNAL Part Number	X mm	Y mm
28	6	5/32				06IR_28BSPT_BC	0,7	0,6
28	16	3/8	16ER_28BSPT_FC	0,6	0,6			
19	8	3/16				08IR_19BSPT_BC	0,6	0,6
19	16	3/8	16ER_19BSPT_FC	0,8	0,9			
14	16	3/8	16ER_14BSPT_FC	1,0	1,2	16IR_14BSPT_FC	1,0	1,2
11	16	3/8	16ER_11BSPT_FC	1,1	1,5	16IR_11BSPT_FC	1,1	1,5

- The Part Numbers are for Right Hand Inserts. For Left Hand specify L instead of R. The Price is 10% higher for L.
- All inserts have ground profile and chipbreaker if nothing else is indicated.

THREAD TURNING INSERTS

NPT

NPT PIPE THREAD

Pitch TPI	L mm	IC inch	EXTERNAL Part Number	X mm	Y mm	INTERNAL Part Number	X mm	Y mm
27	6	5/32				06IR_27NPT_BC	0,6	0,6
27	8	3/16				08IR_27NPT_BC	0,6	0,6
27	16	3/8	16ER_27NPT_FC	0,7	0,8			
18	8	3/16				08IR_18NPT_BC	0,6	0,6
18	11	1/4				11IR_18NPT_FC	0,8	1,0
18	16	3/8	16ER_18NPT_FC	0,8	1,0			
14	16	3/8	16ER_14NPT_FC	0,9	1,2	16IR_14NPT_FC	0,9	1,2
11,5	16	3/8	16ER_11.5NPT_FC	1,1	1,5	16IR_11.5NPT_FC	1,1	1,5
8	16	3/8	16ER_8NPT_FC	1,3	1,8	16IR_8NPT_FC	1,3	1,8

NPTF

NPTF DRYSEAL PIPE THREAD

Pitch TPI	L mm	IC inch	EXTERNAL Part Number	X mm	Y mm	INTERNAL Part Number	X mm	Y mm
27	6	5/32				06IR_27NPTF_BC	0,7	0,6
27	8	3/16				08IR_27NPTF_BC	0,6	0,6
27	16	3/8	16ER_27NPTF_FC	0,7	0,7			
18	8	3/16				08IR_18NPTF_BC	0,6	0,6
18	11	1/4				11IR_18NPTF_FC	0,8	1,0
18	16	3/8	16ER_18NPTF_FC	0,8	1,0			
14	16	3/8	16ER_14NPTF_FC	0,9	1,2	16IR_14NPTF_FC	0,9	1,2
11,5	16	3/8	16ER_11.5NPTF_FC	1,1	1,5	16IR_11.5NPTF_FC	1,1	1,5
8	16	3/8	16ER_8NPTF_FC	1,3	1,8	16IR_8NPTF_FC	1,3	1,8

ABUT

AMERICAN BUTTRESS

Pitch TPI	L mm	IC inch	EXTERNAL Part Number	X mm	Y mm	INTERNAL Part Number	X mm	Y mm
20	11	1/4				11IR_20ABUT_FC	1,0	1,3
16	11	1/4				11IR_16ABUT_FC	1,0	1,5
20	16	3/8	16ER_20ABUT_FC	1,0	1,3	16IR_20ABUT_FC	1,0	1,3
16	16	3/8	16ER_16ABUT_FC	1,0	1,5	16IR_16ABUT_FC	1,0	1,5
12	16	3/8	16ER_12ABUT_FC	1,4	2,0	16IR_12ABUT_FC	1,4	2,0
10	16	3/8	16ER_10ABUT_FC	1,5	2,3	16IR_10ABUT_FC	1,5	2,3
8	22	1/2	22ER_8ABUT_FC	2,1	3,3	22IR_8ABUT_FC	2,1	3,3
6	22	1/2	22ER_6ABUT_FC	2,1	3,4	22IR_6ABUT_FC	2,1	3,4

SG

BUTTRESS (SÄGENGEWINDE) DIN 513/514

Pitch mm	L mm	IC inch	EXTERNAL Part Number	X mm	Y mm	INTERNAL Part Number	X mm	Y mm
2,0	16	3/8	16ER_2.0SG_FC	1,1	1,6	16IR_2.0SG_FC	1,2	1,7
3,0	22	3/8	22ER_3.0SG_FC	1,5	2,4	22IR_3.0SG_FC	1,9	2,9
4,0	22	1/2	22ER_4.0SG_FC	1,9	3,1	22IR_4.0SG_FC	2,3	3,5

PG

STEEL CONDUIT THREAD DIN 40430

Pitch TPI	L mm	IC inch	EXTERNAL Part Number	X mm	Y mm	INTERNAL Part Number	X mm	Y mm
20	8	3/16				08IR_20PG_BC	0,6	0,7
18	11	1/4				11IR_18PG_FC	0,8	0,9
20	16	3/8	16ER_20PG_FC	0,7	0,8			
18	16	3/8	16ER_18PG_FC	0,8	0,9	16IR_18PG_FC	0,8	0,9
16	16	3/8	16ER_16PG_FC	0,8	1,0	16IR_16PG_FC	0,8	1,0

THREAD TURNING INSERTS

TR

TRAPEZ DIN 103

Pitch mm	L mm	IC inch	EXTERNAL Part Number	X mm	Y mm	INTERNAL Part Number	X mm	Y mm
1,5	16	3/8	16ER_1.5TR_FC	1,0	1,1			
2,0	16	3/8	16ER_2.0TR_FC	1,0	1,3	16IR_2.0TR_FC	1,0	1,3
3,0	16	3/8	16ER_3.0TR_FC	1,3	1,5	16IR_3.0TR_FC	1,3	1,5
4,0	22	1/2	22ER_4.0TR_FC	1,8	1,9	22IR_4.0TR_FC	1,8	1,9
5,0	22	1/2	22ER_5.0TR_FC	2,0	2,4	22IR_5.0TR_FC	2,0	2,4
6,0	22	1/2	22ER_6.0TR_FC	2,0	2,4	22IR_6.0TR_FC	2,0	2,4
6,0	27	5/8	27ER_6.0TR_FC	2,3	2,7	27IR_6.0TR_FC	2,3	2,7
7,0	27	5/8	27ER_7.0TR_FC	2,2	2,6	27IR_7.0TR_FC	2,2	2,6

RD

ROUND DIN 405

Pitch TPI	L mm	IC inch	EXTERNAL Part Number	X mm	Y mm	INTERNAL Part Number	X mm	Y mm
10	16	3/8	16ER_10RD_FC	1,1	1,2	16IR_10RD_FC	1,1	1,2
8	16	3/8	16ER_8RD_FC	1,4	1,3	16IR_8RD_FC	1,4	1,4
6	16	3/8	16ER_6RD_FC	1,5	1,7	16IR_6RD_FC	1,4	1,5
6	22	1/2	22ER_6RD_FC	1,5	1,7	22IR_6RD_FC	1,5	1,7
4	22	1/2	22ER_4RD_FC	2,2	2,3	22IR_4RD_FC	2,2	2,3
4	27	5/8	27ER_4RD_FC	2,2	2,3	27IR_4RD_FC	2,2	2,3

ACME

ACME

Pitch TPI	L mm	IC inch	EXTERNAL Part Number	X mm	Y mm	INTERNAL Part Number	X mm	Y mm
16	11	1/4				11IR_16ACME_FC	0,9	1,0
16	16	3/8	16ER_16ACME_FC	0,9	1,0	16IR_16ACME_FC	0,9	1,0
14	16	3/8	16ER_14ACME_FC	1,0	1,2	16IR_14ACME_FC	1,0	1,2
12	16	3/8	16ER_12ACME_FC	1,1	1,2	16IR_12ACME_FC	1,1	1,2
10	16	3/8	16ER_10ACME_FC	1,3	1,3	16IR_10ACME_FC	1,3	1,3
8	16	3/8	16ER_8ACME_FC	1,5	1,5	16IR_8ACME_FC	1,5	1,5
6	16	3/8	16ER_6ACME_FC	1,7	1,8	16IR_6ACME_FC	1,7	1,8
6	22	1/2	22ER_6ACME_FC	1,8	2,1	22IR_6ACME_FC	1,8	2,1
5	22	1/2	22ER_5ACME_FC	2,0	2,3	22IR_5ACME_FC	2,0	2,3
4	27	5/8	27ER_4ACME_FC	2,3	2,7	27IR_4ACME_FC	2,3	2,7

STACME

STUB ACME

Pitch TPI	L mm	IC inch	EXTERNAL Part Number	X mm	Y mm	INTERNAL Part Number	X mm	Y mm
16	16	3/8	16ER_16STACME_FC	1,0	1,0	16IR_16STACME_FC	1,0	1,0
14	16	3/8	16ER_14STACME_FC	1,1	1,1	16IR_14STACME_FC	1,1	1,1
12	16	3/8	16ER_12STACME_FC	1,2	1,2	16IR_12STACME_FC	1,2	1,2
10	16	3/8	16ER_10STACME_FC	1,3	1,3	16IR_10STACME_FC	1,3	1,3
8	16	3/8	16ER_8STACME_FC	1,5	1,5	16IR_8STACME_FC	1,5	1,5
6	16	1/2	16ER_6STACME_FC	1,8	1,8	16IR_6STACME_FC	1,8	1,8
5	22	1/2	22ER_5STACME_FC	2,0	2,3	22IR_5STACME_FC	2,0	2,3
4	27	5/8	27ER_4STACME_FC	2,3	2,4	27IR_4STACME_FC	2,3	2,4
3	27	5/8	27ER_3STACME_FC	2,8	2,9	27IR_3STACME_FC	2,8	2,9

- The Part Numbers are for Right Hand Inserts. For Left Hand specify L instead of R. The Price is 10% higher for L.
- All inserts have ground profile and chipbreaker if nothing else is indicated.

THREAD TURNING INSERTS

API RD

API ROUND OIL THREAD

Pitch TPI	L mm	IC inch	Taper IPF	EXTERNAL Part Number	INTERNAL Part Number	X mm	Y mm
10	16	3/8	0,75	16ER_10APIRD_FC	16IR_10APIRD_FC	1,5	1,4
8	16	3/8	0,75	16ER_8APIRD_FC	16IR_8APIRD_FC	1,3	1,6

V-0.040

V-0.040 OIL THREAD

Pitch TPI	L mm	IC inch	Taper IPF	EXTERNAL Part Number	INTERNAL Part Number	X mm	Y mm	Connection or Size
5	22	1/2	3	22ER_5API403_FC	22IR_5API403_FC	1,8	2,5	2 ³ / ₈ - 4 ¹ / ₂ REG

V-0.038R

V-0.038R OIL THREAD

Pitch TPI	L mm	IC inch	Taper IPF	EXTERNAL Part Number	INTERNAL Part Number	X mm	Y mm	Connection or Size
4	27	5/8	2	27ER_4API382_FC	27IR_4API382_FC	2,1	2,8	NC23-NC50
4	27	5/8	3	27ER_4API383_FC	27IR_4API383_FC	2,1	2,8	NC56-NC77

V-0.050

V-0.050 OIL THREAD

Pitch TPI	L mm	IC inch	Taper IPF	EXTERNAL Part Number	INTERNAL Part Number	X mm	Y mm	Connection or Size
4	27	5/8	2	27ER_4API502_FC	27IR_4API502_FC	2,0	3,0	6 ⁵ / ₈ REG
4	27	5/8	3	27ER_4API503_FC	27IR_4API503_FC	2,0	3,0	5 ¹ / ₂ , 7 ⁵ / ₈ , 8 ⁵ / ₈ REG

EL

EXTREME - LINE CASING OIL THREAD

Pitch TPI	L mm	IC inch	Taper IPF	EXTERNAL Part Number	INTERNAL Part Number	X mm	Y mm	Connection or Size
6	22	1/2	1,50	22ER_6EL1.5_FC	22IR_6EL1.5_FC	1,9	1,9	5 - 7 ⁵ / ₈
5	22	1/2	1,25	22ER_5EL1.25_FC	22IR_5EL1.25_FC	2,4	2,3	8 ⁵ / ₈ - 10 ³ / ₄

BUT

BUTTRESS CASING OIL THREAD

Pitch TPI	L mm	IC inch	Taper IPF	EXTERNAL Part Number	INTERNAL Part Number	X mm	Y mm	Connection or Size
5	22	1/2	0,75	22ER_5BUT0.75_FC	22IR_5BUT0.75_FC	2,2	2,4	4 ¹ / ₂ - 13 ³ / ₈
5	22	1/2	1,00	22ER_5BUT1.0_FC	22IR_5BUT1.0_FC	2,3	2,4	16 - 20

■ The Part Numbers are for Right Hand Inserts. For Left Hand specify L instead of R. The Price is 10% higher for L.

■ All inserts have ground profile and chipbreaker if nothing else is indicated.

THREAD TURNING INSERTS

Triangular Multitooth

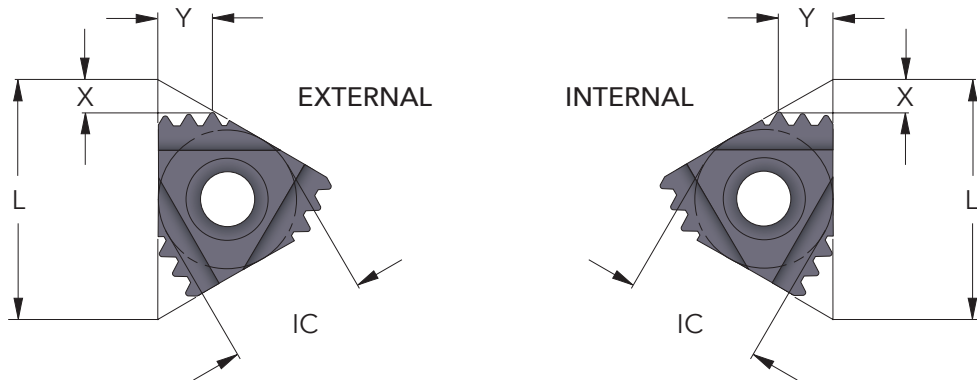

M

METRIC

Pitch mm	L mm	IC inch	EXTERNAL Part Number	X mm	Y mm	INTERNAL Part Number	X mm	Y mm
1,0	16	3/8	16ER_1.0ISO3M_FC	1,7	2,5	16IR_1.0ISO3M_FC	1,7	2,5
1,5	16	3/8	16ER_1.5ISO2M_FC	1,5	2,3	16IR_1.5ISO2M_FC	1,5	2,3
1,5	22	1/2	22ER_1.5ISO3M_FC	2,3	3,7	22IR_1.5ISO3M_FC	2,3	3,7
2,0	22	1/2	22ER_2.0ISO2M_FC	2,0	3,0	22IR_2.0ISO2M_FC	2,0	3,0
2,0	22	1/2	22ER_2.0ISO3M_FC	3,1	5,0	22IR_2.0ISO3M_FC	3,1	5,0
3,0	27	5/8	27ER_3.0ISO2M_FC	2,9	4,5	27IR_3.0ISO2M_FC	2,9	4,5

UN

UNIFIED

Pitch TPI	L mm	IC inch	EXTERNAL Part Number	X mm	Y mm	INTERNAL Part Number	X mm	Y mm
16	16	3/8	16ER_16UN2M_FC	1,5	2,3	16IR_16UN2M_FC	1,5	2,3
16	16	3/8	22ER_16UN3M_FC	2,5	4,0	22IR_16UN3M_FC	2,5	4,0
12	22	1/2	22ER_12UN2M_FC	2,2	3,4	22IR_12UN2M_FC	2,2	3,4
12	22	1/2	22ER_12UN3M_FC	3,3	5,3	22IR_12UN3M_FC	3,3	5,3
8	27	5/8	27ER_8UN2M_FC	3,1	4,9	27IR_8UN2M_FC	3,1	4,9

G/Rp

WHITWORTH PIPE THREAD

Pitch TPI	L mm	IC inch	EXTERNAL Part Number	X mm	Y mm	INTERNAL Part Number	X mm	Y mm
14	16	3/8	16ER_14W2M_FC	1,7	2,7	16IR_14W2M_FC	1,7	2,7
14	22	1/2	22ER_14W3M_FC	2,8	4,5	22IR_14W3M_FC	2,8	4,5
11	22	1/2	22ER_11W2M_FC	2,3	3,4	22IR_11W2M_FC	2,3	3,4

NPT

NPT PIPE THREAD

Pitch TPI	L mm	IC inch	EXTERNAL Part Number	X mm	Y mm	INTERNAL Part Number	X mm	Y mm
11,5	22	1/2	22ER_11.5NPT2M_FC	2,3	3,5	22IR_11.5NPT2M_FC	2,3	3,5
11,5	27	5/8	27ER_11.5NPT3M_FC	3,3	5,5	27IR_11.5NPT3M_FC	3,3	5,5
8	27	5/8	27ER_8NPT2M_FC	3,1	5,0	27IR_8NPT2M_FC	3,1	5,0

API RD

API ROUND OIL THREAD

Pitch TPI	L mm	IC inch	Taper IPF	EXTERNAL Part Number	INTERNAL Part Number	X mm	Y mm
10	22	1/2	0,75	22ER_10APIRD2M_FC	22IR_10APIRD2M_FC	2,4	3,7
10	27	5/8	0,75	27ER_10APIRD3M_FC	27IR_10APIRD3M_FC	3,8	6,2
8	27	5/8	0,75	27ER_8APIRD2M_FC	27IR_8APIRD2M_FC	3,0	4,5

THREAD TURNING INSERTS

Kit with Different Inserts



External Thread Turning Inserts

Part Number 10X16ER_FC		
1 pc. 16ER_0.75ISO_FC	M4,5 MF6-12	1 pc. 16ER_2.0ISO_FC M14-16 MF18-100
1 pc. 16ER_1.0ISO_FC	M6-7 MF8-30	1 pc. 16ER_2.5ISO_FC M18-22
1 pc. 16ER_1.25ISO_FC	M8-9 MF10-12	1 pc. 16ER_3.0ISO_FC M24-27 MF30-100
1 pc. 16ER_1.5ISO_FC	M10-11 MF12-60	1 pc. 16ER_AG55_FC P0,5-3,0
1 pc. 16ER_1.75ISO_FC	M12	1 pc. 16ER_AG60_FC P0,5-3,0

Part Number 10X22ER_FC		
2 pcs. 22ER_3.5ISO_FC	M30-33	
2 pcs. 22ER_4.0ISO_FC	M36-39 MF42-100	
2 pcs. 22ER_4.5ISO_FC	M42-45	
2 pcs. 22ER_5.0ISO_FC	M48-52	
2 pcs. 22ER_N60_FC	P3,5-5,0	

Internal Thread Turning Inserts

Part Number 10X06IR_Ø5_BC		
2 pcs. 06IR_0.5ISO_BC	MF8	
2 pcs. 06IR_0.75ISO_BC	MF7-12	
2 pcs. 06IR_1.0ISO_BC	M7 MF8-30	
2 pcs. 06IR_1.25ISO_BC	M8-9 MF10-12	
2 pcs. 06IR_A60_BC	P0,5-1,25	

Recommended holder: SIR_0005_H06

Part Number 10X08IR_Ø7_BC		
2 pcs. 08IR_1.0ISO_BC	MF10-30	
2 pcs. 08IR_1.5ISO_BC	M10-11 MF12-60	
2 pcs. 08IR_1.75ISO_BC	M12	
2 pcs. 08IR_28W_BC	G1/8	
2 pcs. 08IR_A60_BC	P0,5-1,5	

Recommended holder: SIR_0007_K08

Part Number 10X11IR_Ø10_FC		
2 pcs. 11IR_1.0ISO_FC	MF14-30	
2 pcs. 11IR_1.5ISO_FC	MF14-60	
2 pcs. 11IR_2.0ISO_FC	M14-16 MF18-100	
2 pcs. 11IR_19W_FC	G1/4-3/8	
2 pcs. 11IR_A60_FC	P0,5-1,5	

Recommended holder: SIR_0010_K11

Part Number 10X16IR_Ø13_FC		
2 pcs. 16IR_1.5ISO_FC	MF18-60	
2 pcs. 16IR_2.0ISO_FC	MF18-100	
2 pcs. 16IR_2.5ISO_FC	M18-22	
2 pcs. 16IR_3.0ISO_FC	M24-27 MF30-100	
2 pcs. 16IR_14W_FC	G1/2-7/8	

Recommended holder: SIR_0013_M16

Part Number 10X16IR_Ø20_FC		
2 pcs. 16IR_1.5ISO_FC	MF27-60	
2 pcs. 16IR_2.0ISO_FC	MF27-100	
2 pcs. 16IR_3.0ISO_FC	M27 MF30-100	
2 pcs. 16IR_11W_FC	G1-6	
2 pcs. 16IR_AG60_FC	P0,5-3,0	

Recommended holder: SIR_0020_P16

Part Number 10X22IR_Ø25_FC		
2 pcs. 22IR_3.5ISO_FC	M30-33	
2 pcs. 22IR_4.0ISO_FC	M36-39 MF42-100	
2 pcs. 22IR_4.5ISO_FC	M42-45	
2 pcs. 22IR_5.0ISO_FC	M48-52	
2 pcs. 22IR_N60_FC	P3,5-5,0	

Recommended holder: SIR_0025_R22

THREAD TURNING INSERTS



THREAD TURNING TOOLHOLDERS

External



Insert mm	Part Number	B/H mm	L mm	F mm
16	SER_1212_F16	12	80	16
16	SER_1616_H16	16	100	16
16	SER_2020_K16	20	125	20
16	SER_2525_M16	25	150	25
16	SER_3232_P16	32	170	32
22	SER_2525_M22	25	150	25
22	SER_3232_P22	32	170	32
22	SER_4040_R22	40	200	40
27	SER_2525_M27	25	150	32
27	SER_3232_P27	32	170	32
27	SER_4040_R27	40	200	40

Spare Parts

Insert mm	Screw to insert	Torx key	Screw to anvil	Anvil
16	S16	K16	A16	AE16...
22	S22	K22	A22	AE22...
27	S27	K27	A27	AE27...

■ The Part Numbers are for Right Hand Toolholders. For Left Hand specify L instead of R. The Price is 10% higher for L.

■ Give Helix Angle for Anvil, ex. AE16+0.5

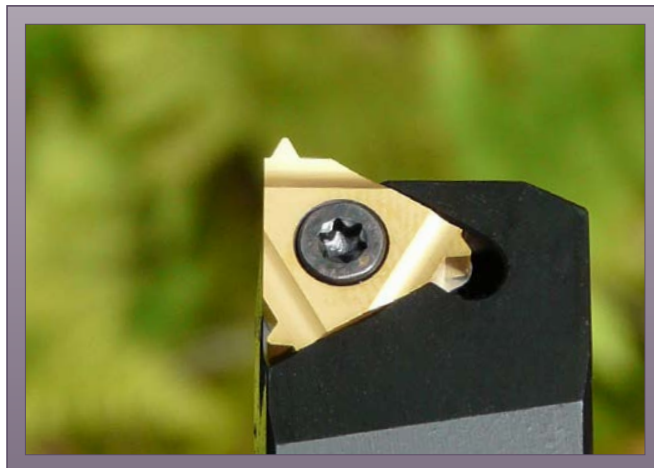

THREAD TURNING TOOLHOLDERS

Internal

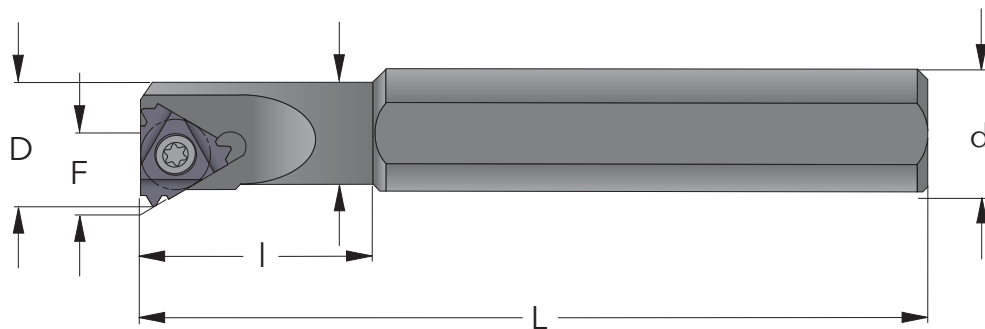

Insert mm	D mm	Part Number	d mm	d1 mm	l mm	L mm	F mm
6	6,3	SIR_0005_H06*	12	5,1	12	100	4,3
8	8	SIR_0007_K08*	16	6,6	18	125	5,3
11	12	SIR_0010_H11*	10	10		100	7,4
11	12	SIR_0010_K11*	16	10	25	125	7,4
11	15	SIR_0013_L11*	16	13	32	140	8,9
16	16	SIR_0013_M16*	16	13	32	150	10,2
16	19	SIR_0016_P16*	20	16	40	170	11,7
16	23	SIR_0020_P16	20	20		170	13,7
16	28	SIR_0025_R16	25	25		200	16,2
16	35	SIR_0032_S16	32	32		250	19,7
16	43	SIR_0040_T16	40	40		300	23,7
22	24	SIR_0020_P22*	20	20		170	15,6
22	29	SIR_0025_R22	25	25		200	18,1
22	36	SIR_0032_S22	32	32		250	21,6
22	44	SIR_0040_T22	40	40		300	25,6
27	39	SIR_0032_S27	32	32		250	22,6
27	45	SIR_0040_T27	40	40		300	26,6
27	55	SIR_0050_U27	50	50		350	31,6
27	65	SIR_0060_V27	60	60		400	36,6

with Carbide Shank and Internal Coolant

Insert mm	D mm	Part Number	d mm	d1 mm	l mm	L mm	F mm
6	6,3	SIR_0005_H06CB*	6	5,1	26	100	4,3
8	8	SIR_0007_K08CB*	8	6,6	31	125	5,3
11	12	SIR_0010_M11CB*	10	10		150	7,4
11	14	SIR_0012_P11CB*	12	12		170	8,4
16	19	SIR_0016_R16CB*	16	16		200	11,7
16	23	SIR_0020_S16CB	20	20		250	13,7
16	28	SIR_0025_S16CB	25	25		250	16,2
22	24	SIR_0020_S22CB*	20	20		250	15,6

Spare Parts

Insert mm	Screw to insert	Torx key	Screw to anvil	Anvil
06	S6	K6		
08	S8	K8		
11	S11	K11		
16	S16	K16	A16	AI16...
22	S22	K22	A22	AI22...
27	S27	K27	A27	AI27...

* Toolholder without anvil

THREAD TURNING INSERTS

U-type

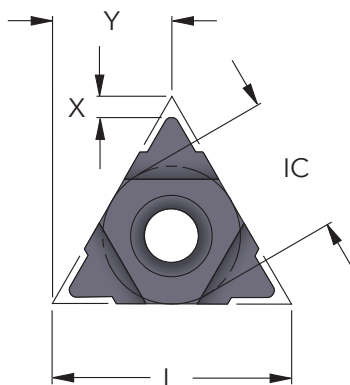

M

METRIC

Pitch mm	L mm	IC inch	EXTERNAL Part Number	X mm	Y mm	INTERNAL Part Number	X mm	Y mm
2,0	8	3/16				08UI_2.0ISO_BC	0,9	4,0
5,5	22	1/2	22UE_5.5ISO_FC	2,3	11,0	22UI_5.5ISO_FC	2,4	11,0
6,0	22	1/2	22UE_6.0ISO_FC	2,6	11,0	22UI_6.0ISO_FC	2,1	11,0
8,0	27	5/8	27UE_8.0ISO_FC	2,4	13,7	27UI_8.0ISO_FC	2,4	13,7
12,0	33	3/4	33UE_12.0ISO_FC	2,5	16,5	33UI_12.0ISO_FC	3,5	16,9

UN

UNIFIED

Pitch TPI	L mm	IC inch	EXTERNAL Part Number	X mm	Y mm	INTERNAL Part Number	X mm	Y mm
13	8	3/16				08UI_13UN_BC	1,0	4,0
12	8	3/16				08UI_12UN_BC	0,9	4,0
11	8	3/16				08UI_11UN_BC	0,9	4,0
4,5	22	1/2	22UE_4.5UN_FC	2,0	11,0	22UI_4.5UN_FC	2,4	11,0
4	22	1/2	22UE_4UN_FC	2,0	11,0	22UI_4UN_FC	2,4	11,0
3	27	5/8	27UE_3UN_FC	2,5	13,7	27UI_3UN_FC	2,7	13,7
2	33	3/4	33UE_2UN_FC	2,8	16,5	33UI_2UN_FC	3,6	16,9

TR

TRAPEZ DIN 103

Pitch mm	L mm	IC inch	EXTERNAL Part Number	X mm	Y mm	INTERNAL Part Number	X mm	Y mm
2,0	8					08UI_2.0TR_BC	0,9	4,0
6,0	22	1/2	22UE_6.0TR_FC	2,0	11,0	22UI_6.0TR_FC	2,0	11,0
7,0	22	1/2	22UE_7.0TR_FC	2,3	11,0	22UI_7.0TR_FC	2,3	11,0
8,0	22	1/2	22UE_8.0TR_FC	2,5	11,0	22UI_8.0TR_FC	2,5	11,0
8,0	27	5/8	27UE_8.0TR_FC	2,5	13,7	27UI_8.0TR_FC	2,5	13,7
9,0	27	5/8	27UE_9.0TR_FC	3,0	13,7	27UI_9.0TR_FC	3,0	13,7
10,0	27	5/8	27UE_10.0TR_FC*	3,2	13,7	27UI_10.0TR_FC*	3,2	13,7
12,0	33	3/4	33UE_12.0TR_FC	3,9	16,9	33UI_12.0TR_FC	3,9	16,9

■ All inserts have ground profile and chipbreaker.

* Only one cutting edge

THREAD TURNING INSERTS

ACME

ACME

Pitch TPI	L mm	IC inch	EXTERNAL Part Number	X mm	Y mm	INTERNAL Part Number	X mm	Y mm
14	8	3/16				08UI_14ACME_BC	0,8	4,0
12	8	3/16				08UI_12ACME_BC	0,8	4,0
10	8	3/16				08UI_10ACME_BC	0,8	4,0
4	22	1/2	22UE_4ACME_FC	2,3	11,0	22UI_4ACME_FC	2,3	11,0
3	27	5/8	27UE_3ACME_FC	2,8	13,7	27UI_3ACME_FC	2,8	13,7
2	33	3/4	33UE_2ACME_FC	4,3	16,9	33UI_2ACME_FC	4,3	16,9

STACME

STUB ACME

Pitch TPI	L mm	IC inch	EXTERNAL Part Number	X mm	Y mm	INTERNAL Part Number	X mm	Y mm
14	8	3/16				08UI_14STACME_BC	0,8	4,0
12	8	3/16				08UI_12STACME_BC	0,9	4,0
10	8	3/16				08UI_10STACME_BC	1,0	4,0
4	22	1/2	22UE_4STACME_FC	2,5	11,0	22UI_4STACME_FC	2,5	11,0
3	22	1/2	22UE_3STACME_FC	3,3	11,0	22UI_3STACME_FC	3,3	11,0
2	33	3/4	33UE_2STACME_FC	5,0	16,9	33UI_2STACME_FC	5,0	16,9

BS/G/Rp

WHITWORTH

Pitch TPI	L mm	IC inch	EXTERNAL Part Number	X mm	Y mm	INTERNAL Part Number	X mm	Y mm
12	8	3/16				08UI_12W_BC	0,9	4,0
4,5	22	1/2	22U_4.5W_FC	2,3	11,0	22U_4.5W_FC	2,3	11,0
4	22	1/2	22U_4W_FC	2,8	11,0	22U_4W_FC	2,8	11,0
3,5	27	5/8	27U_3.5W_FC	2,1	13,7	27U_3.5W_FC	2,1	13,7
3,25	27	5/8	27U_3.25W_FC	2,0	13,7	27U_3.25W_FC	2,0	13,7
3	27	5/8	27U_3W_FC	2,3	13,7	27U_3W_FC	2,3	13,7
2,75	27	5/8	27U_2.75W_FC	2,4	13,7	27U_2.75W_FC	2,4	13,7

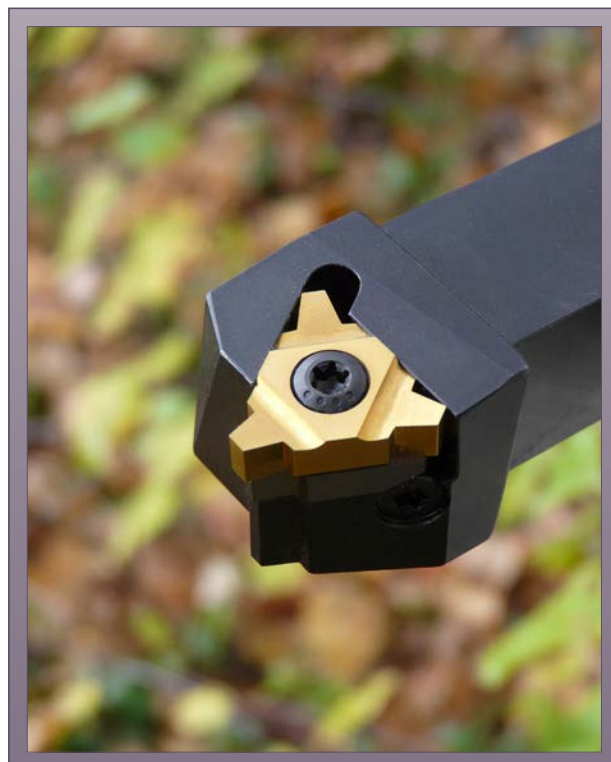

THREAD TURNING TOOLHOLDERS

U-type External



Insert mm	Part Number	B/H mm	L mm	F mm
22	SER_2525_M22U	25	150	28
22	SER_3232_P22U	32	170	32
22	SER_4040_R22U	40	200	40
27	SER_2525_M27U	25	150	32
27	SER_3232_P27U	32	170	32
27	SER_4040_R27U	40	200	40
33	SER_2525_M33U*	25	150	32
33	SER_3232_P33U*	32	170	32

Spare Parts

Insert mm	Screw to insert	Torx key	Screw to anvil	Anvil
22	S22	K22	A22	AE22U...
27	S27	K27	A27	AE27U...
33	S33	K33		

■ The Part Numbers are for Right Hand Toolholders. For Left Hand specify L instead of R. The Price is 10% higher for L.

■ Give Helix Angle for Anvil, ex. AE22U+0.5

* Toolholder without anvil

THREAD TURNING TOOLHOLDERS

U-type Internal

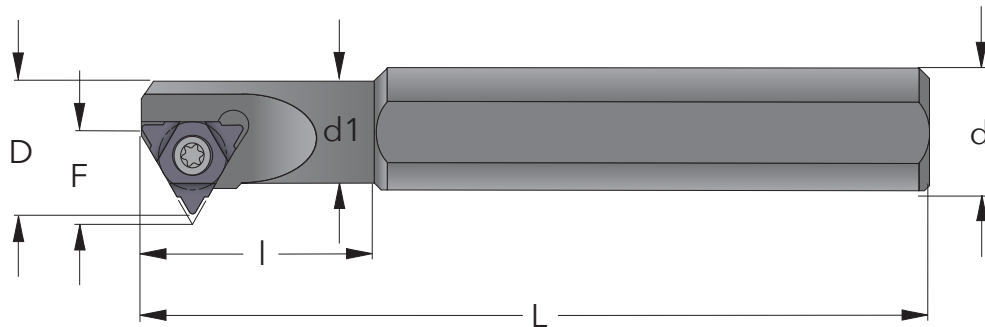

Insert mm	D mm	Part Number	d mm	d1 mm	l mm	L mm	F mm
8	9,5	SIR_0008_K08U*	16	7,3	21	125	6,6
22	39	SIR_0032_S22U	32	32	-	250	24,4
22	46	SIR_0040_T22U	40	40	-	300	28,1
27	40	SIR_0032_S27U	32	32	-	250	25,8
27	47	SIR_0040_T27U	40	40	-	300	29,4
27	57	SIR_0050_U27U	50	50	-	350	34,3
27	68	SIR_0060_V27U	60	60	-	400	39,7
33	59	SIR_0050_U33U*	50	50	-	350	37,5

with Carbide Shank and Internal Coolant

Insert mm	D mm	Part Number	d mm	d1 mm	l mm	L mm	F mm
8	9,5	SIR_0008_K08UCB*	8	7,3	35	125	6,6

Spare Parts

Insert mm	Screw to insert	Torx key	Screw to anvil	Anvil
08	S8	K8		
22	S22	K22	A22	AI22U...
27	S27	K27	A27	AI27U...
33	S33	K33		

■ The Part Numbers are for Right Hand Toolholders. For Left Hand specify L instead of R. The Price is 10% higher for L.

■ Give Helix Angle for Anvil, ex. AI22U+0.5

* Toolholder without anvil

THREAD TURNING INSERTS

Micro

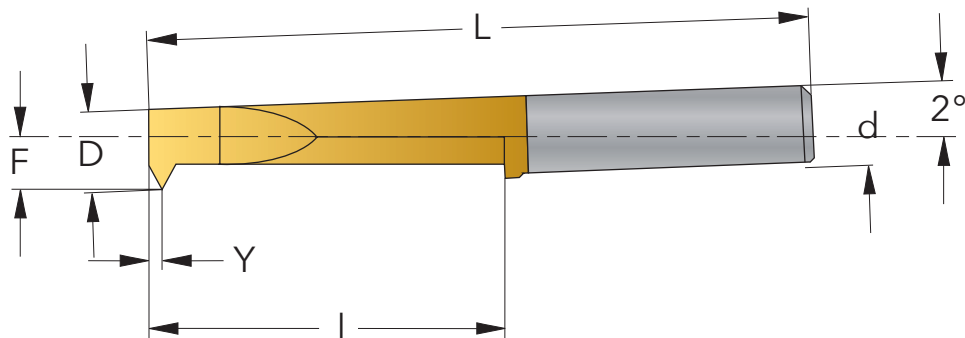

60°

PARTIAL PROFILE 60°

Pitch mm	TPI	D mm	INTERNAL Part Number	d mm	l mm	L mm	F mm	Y mm
0,2-0,4	80 - 64	0,8	WR308_P60_BC	3	4	24	0,5	0,2
0,2-0,6	80 - 44	1,6	WR316_P60_BC	3	7	24	0,75	0,3
0,2-0,8	80 - 32	2,2	WR322_P60_BC	3	10	24	1,25	0,4
0,2-1,0	80 - 28	3,0	WR330_P60_BC	3	12	24	1,5	0,5
0,25-1,25	80 - 20	4,0	WR440_P60_BC	4	16,5	32	2	0,6
0,25-1,5	80 - 18	5,0	WR550_P60_BC	5	21	40	2,5	0,7
0,25-1,75	80 - 14	6,0	WR660_P60_BC	6	27	48	3	0,8
0,35-2,5	72 - 10	8,0	WR880_P60_BC	8	45	72	4	1,2

55°

PARTIAL PROFILE 55°

Pitch mm	TPI	D mm	INTERNAL Part Number	d mm	l mm	L mm	F mm	Y mm
0,25-1,25	80 - 20	4,0	WR440_P55_BC	4	16,5	32	2	0,6
0,25-1,75	80 - 18	6,0	WR660_P55_BC	6	27	48	3	0,8

■ Also available for Grooving and Turning

Minimum Bore Diameter

To obtain highest possible stability the threading inserts are ground in an angle of 2°. Therefore the minimum bore diameter is dependent on the thread length according to the table below.

D mm	Thread Length (mm)															
	2	4	6	8	10	12	14	16	18	21	24	27	30	35	40	45
0,8	0,87	0,94														
1,6	1,67	1,74	1,81													
2,2	2,27	2,34	2,41	2,48	2,55											
3,0	3,07	3,14	3,21	3,28	3,35	3,42										
4,0	4,07	4,14	4,21	4,28	4,35	4,42	4,49	4,56								
5,0	5,07	5,14	5,21	5,28	5,35	5,42	5,49	5,56	5,63	5,74						
6,0	6,07	6,14	6,21	6,28	6,35	6,42	6,49	6,56	6,63	6,74	6,84	6,95				
8,0	8,07	8,14	8,21	8,28	8,35	8,42	8,49	8,56	8,63	8,74	8,84	8,95	9,05	9,23	9,40	9,58

■ Minimum Bore Diameter = D + (thread length x 0,035)

THREAD TURNING TOOLHOLDERS

Micro

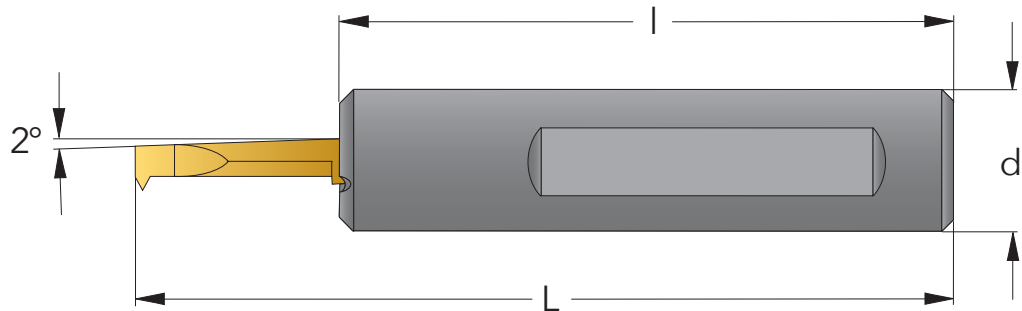

Insert mm	Part Number	d mm	l mm	L mm
3,0	WRC3N_0012E-2	12	70	82
3,0	WRC3N_0016F-2	16	80	92
3,0	WRC3N_0020H-2	20	100	112
3,0	WRC3N_0022J-2	22	110	122
3,0	WRC3N_0025J-2	25	110	122
4,0	WRC4N_0012E-2	12	75	91,5
4,0	WRC4N_0016F-2	16	85	101,5
4,0	WRC4N_0020H-2	20	105	121,5
4,0	WRC4N_0022J-2	22	115	131,5
4,0	WRC4N_0025J-2	25	115	131,5
5,0	WRC5N_0016G-2	16	90	111
5,0	WRC5N_0020J-2	20	110	131
5,0	WRC5N_0022J-2	22	120	141
5,0	WRC5N_0025J-2	25	120	141
6,0	WRC6N_0016G-2	16	95	121
6,0	WRC6N_0020J-2	20	115	141
6,0	WRC6N_0022K-2	22	125	151
6,0	WRC6N_0025K-2	25	125	151
8,0	WRC8N_0020J-2	20	120	165
8,0	WRC8N_0022K-2	22	130	175
8,0	WRC8N_0025K-2	25	130	175

■ Also available in 3/4" and 1" (for Citizen).







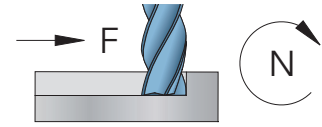



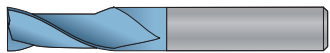

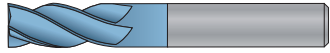







Technical Information

68

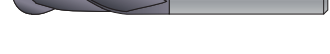

SOLID CARBIDE END MILLS

LC	M	Two Flute	78	
LC	M	Three Flute	79	
LC	M	Four Flute	80	
LC	R	Two Flute, with Ball Nose	81	
LC	MZ	Variable Flute 35° and 38°	82	
LC	MV	Slot Side End Mill	83	
LC	FW	Wave formed Roughing End Mill, Three Flute	84	
LC	FW	Wave formed Roughing End Mill, Four Flute	85	
MG	MA	Two Flute, for aluminium	86	
MG	MA	Three Flute, for aluminium	87	
MG	FWA	Wave formed Roughing End Mill, aluminium	88	
FC	M	Two Flute	89	
FC	M	Three Flute	90	
FC	M	Four Flute	91	
FC	M..R	Two Flute, with Corner Radius	92	
FC	M..R	Four Flute, with Corner Radius	93	
FC	R	Two Flute, with Ball Nose	94	
FC	R..L	Two Flute, with Ball Nose, Long Shank	94	
FC	R	Four Flute, with Ball Nose	95	

FC	U	High Helix	96
FC	V	High Helix, for Hard Materials	97



MOLD AND DIE END MILLS

FC	MP	Micro, Two Flute	98
FC	RP	Micro, Two Flute, with Ball Nose	100
FC	MH	Two Flute, with Corner Radius	102
FC	MH	Four Flute, with Corner Radius	103
FC	RH	Two Flute, with Ball Nose	104
FC	RH	Four Flute, with Ball Nose	105
FC	TH	Roughing End Mill	107

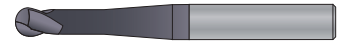
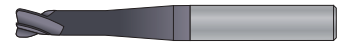

DIAMOND COATED END MILLS

DC	MG	Micro, Two Flute	108
DC	RG	Micro, Two Flute, with Ball Nose	109
DC	MG	Three Flute, with Corner Radius	110
DC	MG..L	Two Flute, with Corner Radius, Long Shank	110
DC	MG	Two/Four Flute, with Corner Radius	111
DC	RG	Three Flute, with Ball Nose	112
DC	RG..L	Two Flute, with Ball Nose, Long Shank	112
DC	RG	Two/Four Flute, with Ball Nose	113

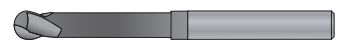
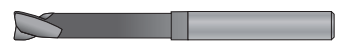

Cutting Speed (V_c) and Material Factor (F_m)

MATERIAL		Hardness HB	Tensile Strength N/mm ²	Cutting Speed (V_c) m/min	Material Factor (F_m)
Steel	Low carbon, C < 0,25%	< 120	< 400	150 - 200	1,2
	Medium carbon, C < 0,55%	< 200	< 700	120 - 170	1,1
	High carbon, C < 0,85%	< 250	< 850	110 - 150	1,0
	Low alloy	< 250	< 850	100 - 140	1,0
	High alloy	< 350	< 1200	70 - 110	0,9
	Hardened, HRC < 45			60 - 100	0,8
	Hardened, HRC < 55			30 - 60	0,7
	Hardened, HRC < 65			20 - 40	0,6
Cast iron	Lamellar graphite	< 150	< 500	130 - 180	1,2
	Lamellar graphite	< 300	< 1000	100 - 150	1,1
	Nodular graphite, malleable	< 200	< 700	100 - 150	1,0
	Nodular graphite, malleable	< 300	< 1000	80 - 120	0,9
Stainless steel	Free machining	< 250	< 850	130 - 180	1,0
	Austenitic	< 250	< 850	90 - 140	0,9
	Ferritic and austenitic	< 300	< 1000	80 - 120	0,8
Titanium	Unalloyed	< 200	< 700	60 - 80	0,8
	Alloyed	< 270	< 900	50 - 70	0,7
	Alloyed	< 350	< 1250	30 - 50	0,6
Nickel	Unalloyed	< 150	< 500	80 - 120	0,8
	Alloyed	< 270	< 900	60 - 80	0,7
	Alloyed	< 350	< 1250	50 - 70	0,6
Copper	Unalloyed	< 100	< 350	150 - 250	1,0
	Brass, bronze	< 200	< 700	130 - 180	1,0
	High strength bronze	< 470	< 1500	60 - 80	0,8
Aluminium	Unalloyed	< 100	< 350	500 - 900	1,4
	Alloyed, Si < 0.5%	< 150	< 500	400 - 800	1,3
	Alloyed, Si < 10%	< 120	< 400	300 - 500	1,2
	Alloyed, Si > 10%	< 120	< 400	200 - 400	1,1
Inconel	718	< 370		50 - 70	0,6
Graphite				300 - 500	1,0

Code Key

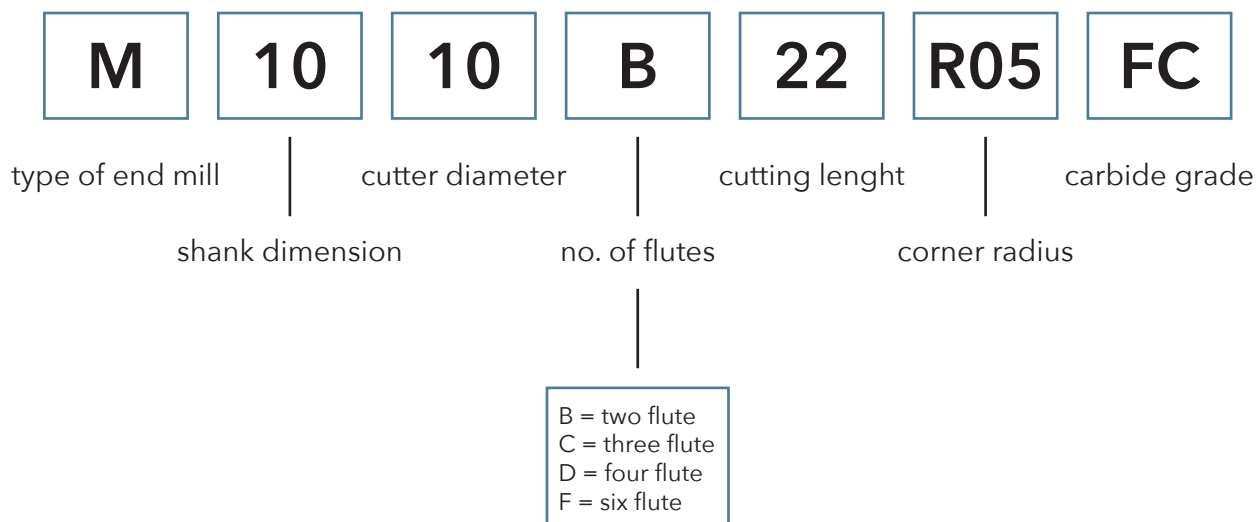

Engagement Factor (F_e)

	Side Milling				Slot Milling $a_e = 1,0 \times D$
	$a_e = 0,1 \times D$	$a_e = 0,25 \times D$	$a_e = 0,5 \times D$	$a_e = 0,75 \times D$	
$a_p = 0,25 \times D$	3,5	1,8	1,4	1,2	1,0
$a_p = 0,5 \times D$	3,0	1,5	1,2	0,9	0,7
$a_p = 0,75 \times D$	2,5	1,3	1,0	0,7	0,6
$a_p = 1,0 \times D$	2,0	1,1	0,8	0,6	0,5
$a_p = 1,25 \times D$	1,7	0,9	0,6		
$a_p = 1,5 \times D$	1,4	0,7			
$a_p = 2,0 \times D$	1,2	0,5			
$a_p = 2,5 \times D$	1,0				
$a_p = 3,0 \times D$	0,8				

Side Milling

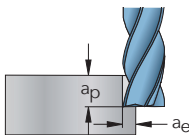

$$F_z = F_m \times F_e \times F_d$$

Slot Milling

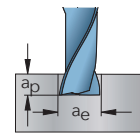
Diameter Factor (F_d)

D	Diameter Factor (F_d)
0,5	0,004
1,0	0,006
2,0	0,009
3,0	0,012
4,0	0,016
5,0	0,022
6,0	0,032
8,0	0,045
10,0	0,056
12,0	0,074
14,0	0,086
16,0	0,098
18,0	0,110
20,0	0,122
25,0	0,135
32,0	0,145
40,0	0,155

D = cutter diameter (mm)

F_z = feed / flute (mm/flute)

n = spindle speed (rpm)

V_c = cutting speed (m/min)

V_f = table feed (mm/min)

z = no. of flutes

Example

Side Milling with M1010D25 LC
Standard Length Four Flute End Mill
Carbon Steel, up to 700 N/mm²

D = 10 mm

$a_p = 1,0 \times D = 10$ mm

$a_e = 0,25 \times D = 2,5$ mm

$F_z = 1,1 \times 1,1 \times 0,056 = 0,068$ mm/flute

$n = (130 \times 1000) / (n \times 10) = 4138$ rpm

$V_f = 0,068 \times 4 \times 4138 = 1126$ mm/min

$$n = \frac{V_c \times 1000}{\pi \times D}$$

$$V_f = F_z \times z \times n$$

Carbide Grades

LC

Super Micrograin Carbide with AlCrN coating. Allround Grade with extremely high heat resistance. Use cutting data according to the tables.

MG

Uncoated Super Micrograin Carbide. For Aluminium. Use cutting data according to the tables.

FC

Micrograin Carbide with TiAlN coating. Allround Grade with high heat resistance. Use cutting data according to the tables.

DC

Micrograin Carbide with Diamond coating. For Graphite. Use cutting data according to the tables.

$$\text{Spindle Speed (rpm)} = \frac{V_c \times 1000}{\pi \times D}$$

D (mm)	20	25	30	35	40	45	50	55	60	65	70	75	80	85	90	95	100	110	120	130	140	150	160	180	200	230	260	300	350	400	450	
0.3	21221	26526	31831	42441	53052	63662	74272	84883	95493																							
0.4	15916	19894	23873	31831	39789	47747	55704	63662	71620	79578	87535	95493																				
0.5	12732	15916	19099	25465	31831	38197	44563	50930	57296	63662	70028	76394	82761	89127																		
0.6	10610	13263	15916	21221	26526	31831	37136	42441	47747	53052	58357	63662	68967	74272	79578	84883	90188															
0.7	9095	11368	13642	18189	22736	27284	31831	36378	40926	45473	50020	54567	59115	63662	68210	72757	77304	81851	86398	90945												
0.8	7958	9947	11937	15916	19894	23873	27852	31831	35810	39789	43768	47747	51725	55704	59683	63662	67641	71620	75599	79578	83557	87535	91514									
0.9	7074	8842	10610	14147	17684	21221	24757	28294	31831	35368	38905	42441	45978	49515	53052	56589	60126	63662	67203	70740	74277	77814	81351	84888	88425	91962						
1.0	6366	7958	9549	12732	15916	19099	22282	25465	28648	31831	35014	38197	41380	44563	47747	50930	54113	57296	60479	63662	66845	70028	73211	76394	79578	82761	85944					
1.1	5787	7234	8681	11575	14469	17362	20256	23150	26044	28938	31831	34725	37618	40512	43406	46300	49194	52088	54982	57876	60770	63664	66558	69452	72346	75240	78134	81028				
1.2	5305	6631	7958	10610	13263	15916	18568	21221	23873	26526	29178	31831	34484	37136	39789	42441	45094	47747	50399	53052	55704	58357	61010	63662	66315	68968	71621	74274				
1.3	4897	6121	7346	9794	12243	14691	17140	19588	22037	24485	26934	29382	31831	34280	36729	39178	41627	44076	46525	48974	51423	53872	56321	58770	61219	63668	66117	68566				
1.4	4547	5684	6821	9095	11368	13642	15916	18189	20463	22736	25010	27284	29557	31831	34104	36378	38652	40926	43200	45474	47747	50020	52294	54567	56841	59115	61389	63662				
1.5	4244	5305	6366	8488	10610	12732	14854	16977	19099	21221	23343	25465	27587	29709	31831	33953	36075	38197	40319	42441	44563	46685	48807	50929	53051	55173	57295	59417				
1.6	3979	4974	5968	7958	9947	11937	13926	15916	17905	19894	21884	23873	25863	27852	29841	31831	33820	35810	37800	39789	41778	43768	45757	47747	49736	51725	53715	55704				
1.7	3745	4681	5617	7490	9362	11234	13107	14979	16852	18724	20597	22469	24341	26214	28087	29959	31831	33703	35575	37447	39319	41191	43063	44935	46807	48679	50551	52423				
1.9	3351	4188	5026	6701	8377	10052	11727	13403	15078	16753	18428	20104	21779	23454	25129	26804	28479	30154	31829	33504	35179	36854	38529	40204	41879	43554	45229	46904				
2.0	3183	3979	4775	6366	7958	9549	11141	12732	14324	15916	17507	19099	20690	22282	23873	25465	27056	28648	30239	31831	33423	35014	36606	38197	39789	41380	42971	44563				
2.2	2894	3617	4341	5787	7234	8681	10128	11575	13022	14469	15916	17362	18809	20256	21703	23150	24597	26044	27491	28938	30385	31831	33278	34725	36172	37619	39066	40513				
2.3	2768	3460	4152	5536	6920	8304	9688	11072	12456	13840	15224	16608	18000	19392	20784	22176	23568	24960	26352	27744	29136	30528	31920	33312	34704	36096	37488	38880				
2.5	2546	3183	3820	5093	6366	7639	8913	10186	11459	12732	14006	15279	16552	17825	19099	20372	21645	22918	24191	25464	26737	28010	29283	30556	31829	33102	34375	35648				
2.6	2449	3061	3673	4897	6121	7346	8570	9794	11018	12243	13467	14691	15916	17140	18364	19588	20812	22036	23260	24484	25708	26932	28156	29380	30604	31828	33052	34276				
2.8	2274	2842	3410	4547	5684	6821	7958	9095	10231	11368	12505	13642	14779	15916	17053	18190	19327	20464	21601	22738	23875	25012	26149	27286	28423	29560	30697	31834				
3.0	2122	2653	3183	4244	5305	6366	7427	8488	9549	10610	11671	12732	13793	14854	15915	16976	18037	19098	20159	21220	22281	23342	24403	25464	26525	27586	28647	29708				
3.5	1819	2274	2728	3638	4547	5456	6366	7275	8185	9095	10004	10913	11823	12732	13641	14550	15459	16368	17277	18186	19095	20004	20913	21822	22731	23640	24549	25458				
3.6	1768	2210	2653	3537	4421	5305	6189	7074	7958	8842	9726	10610	11495	12379	13264	14149	15034	15919	16804	17689	18574	19459	20344	21229	22114	22999	23884					
3.7	1721	2151	2581	3441	4301	5162	6022	6882	7743	8603	9463	10324	11184	12044	12904	13765	14625	15485	16345	17205	18065	18925	19785	20645	21505	22365	23225					
4.0	1592	1989	2387	3183	3979	4775	5570	6366	7162	7958	8754	9549	10345	11141	11937	12732	13528	14324	15120	15916	16712	17508	18304	19100	19896	20692	21488					
4.5	1415	1768	2122	2829	3537	4244	4951	5659	6366	7074	7781	8488	9196	9903	10610	11318	12026	12734	13442	14150	14858	15566	16274	16982	17690	18398	19106					
5.0	1273	1592	1910	2546	3183	3820	4456	5093	5730	6366	7003	7639	8276	8913	9550	10186	10823	11460	12097	12734	13371	14008	14645	15282	15919	16556	17193					
6.0	1061	1326	1592	2122	2653	3183	3714	4244	4775	5305	5836	6366	6897	7427	7958	8488	9019	9549	10079	10609	11139	11669	12199	12729	13259	13789	14319					
7.0	909	1137	1364	1819	2274	2728	3183	3638	4093	4547	5002	5457	5911	6366	6821	7276	7731	8186	8641	9096	9551	10006	10461	10916	11371	11826	12281					
8.0	796	995	1194	1592	1989	2387	2785	3183	3581	3979	4377	4775	5173	5570	5968	6366	6764	7162	7560	7958	8356	8754	9152	9550	9948	10346	10744					
9.0	707	884	1061	1415	1768	2122	2476	2829	3183	3537	3890	4244	4598	4951	5305	5659	6013	6366	6720	7074	7428	7781	8135	8488	8842	9196	9550					
10.0	637	796	955	1273	1592	1910	2228	2546	2865	3183	3501	3820	4138	4456	4775	5093	5411	5730	6048	6366	6684	7003	7321	7639	7958	8276	8594					
11.0	579	723	868	1157	1447	1736	2026	2315	2604	2894	3183	3472	3762	4051	4340	4630	4919	5209	5498	5787	6076	6366	6655	6945	7234	7524	7813					
12.0	531	663	796	1061	1326	1592	1857	2122	2387	2653	2918	3183	3448	3714	3979	4244	4509	4774	5039	5304	5569	5834	6099	6364	6629	6894	7159					
14.0	455	568	682	909	1137	1364	1592	1819	2046	2274	2501	2728	2956	3183	3410	3637	3864	4091	4318	4545	4772	5000	5227	5454	5681	5908	6135					
15.0	424	531	637	849	1061	1273	1485	1698	1910	2122	2334	2546	2759	2971	3183	3395	3607	3819	4031	4243	4455	4667	4879	5091	5303	5515	5727					
16.0	398	497	597	796	995	1194	1393	1592	1790	1989	2188	2387	2586	2785	2984	3183	3382	3581	3780	3979	4178	4377	4576	4775	4974	5173	5372					
18.0	354	442	531	707	884	1061	1238	1415	1592	1768	1945	2122	2299	2476	2653	2830	3007	3184	3361	3538	3715	3892	4069	4246	4423	4600	4777					
20.0	318	398	477	637	796	955	1114	1273	1432	1591	1750	1909	2068	2227	2386	2545	2704	2863	3022	3181	3340	3499	3658	3817	3976	4135	4294					
22.0	289	362	434	579	723	868	1013	1157	1302	1447	1592	1736	1881	2026	2171	2315	2460	2604	2749	2894	3039	3184	3329	3474	3619	3764	3909					
25.0	255	318	382	509	637	764	891	1019	1146	1273	1401	1528																				

$$\text{Feed (mm/min)} = F_z \times z \times n$$



Fz (mm/z)		n (rpm)																					
z2	z3	z4	200	350	500	750	1000	1250	1500	2000	2500	3000	4000	5000	6000	8000	10000	15000	20000	25000	30000	40000	50000
0,001	0,001	0,001	1	1	2	3	4	5	6	8	10	12	16	20	24	32	40	60	80	100	120	160	200
0,002	0,002	0,002	1	2	3	5	6	8	9	12	15	18	24	30	36	48	60	90	120	150	180	240	300
0,004	0,003	0,002	2	3	4	6	8	10	12	16	20	24	32	40	48	64	80	120	160	200	240	320	400
0,005	0,003	0,003	2	4	5	8	10	13	15	20	25	30	40	50	60	80	100	150	200	250	300	400	500
0,006	0,004	0,003	2	4	6	9	12	15	18	24	30	36	48	60	72	96	120	180	240	300	360	480	600
0,007	0,005	0,004	3	5	7	11	14	18	21	28	35	42	56	70	84	112	140	210	280	350	420	560	700
0,008	0,005	0,004	3	6	8	12	16	20	24	32	40	48	64	80	96	128	160	240	320	400	480	640	800
0,009	0,006	0,005	4	6	9	14	18	23	27	36	45	54	72	90	108	144	180	270	360	450	540	720	900
0,010	0,007	0,005	4	7	10	15	20	25	30	40	50	60	80	100	120	160	200	300	400	500	600	800	1000
0,012	0,008	0,006	5	8	12	18	24	30	36	48	60	72	96	120	144	192	240	360	480	600	720	960	1200
0,014	0,009	0,007	6	10	14	21	28	35	42	56	70	84	112	140	168	224	280	420	560	700	840	1120	1400
0,016	0,011	0,008	6	11	16	24	32	40	48	64	80	96	128	160	192	256	320	480	640	800	960	1280	1600
0,018	0,012	0,009	7	13	18	27	36	45	54	72	90	108	144	180	216	288	360	540	720	900	1080	1440	1800
0,020	0,013	0,010	8	14	20	30	40	50	60	80	100	120	160	200	240	320	400	600	800	1000	1200	1600	2000
0,022	0,015	0,011	9	15	22	33	44	55	66	88	110	132	176	220	264	352	440	660	880	1100	1320	1760	2200
0,024	0,016	0,012	10	17	24	36	48	60	72	96	120	144	192	240	288	384	480	720	960	1200	1440	1920	2400
0,026	0,017	0,013	10	18	26	39	52	65	78	104	130	156	208	260	312	416	520	780	1040	1300	1560	2080	2600
0,028	0,019	0,014	11	20	28	42	56	70	84	112	140	168	224	280	336	448	560	840	1120	1400	1680	2240	2800
0,030	0,020	0,015	12	21	30	45	60	75	90	120	150	180	240	300	360	480	600	900	1200	1500	1800	2400	3000
0,035	0,023	0,018	14	25	35	53	70	88	105	140	175	210	280	350	420	560	700	1050	1400	1750	2100	2800	3500
0,040	0,027	0,020	16	28	40	60	80	100	120	160	200	240	320	400	480	640	800	1200	1600	2000	2400	3200	4000
0,045	0,030	0,023	18	32	45	68	90	113	135	180	225	270	360	450	540	720	900	1350	1800	2250	2700	3600	4500
0,050	0,033	0,025	20	35	50	75	100	125	150	200	250	300	400	500	600	800	1000	1500	2000	2500	3000	4000	5000
0,055	0,037	0,028	22	39	55	83	110	138	165	220	275	330	440	550	660	880	1100	1650	2200	2750	3300	4400	5500
0,060	0,040	0,030	24	42	60	90	120	150	180	240	300	360	480	600	720	960	1200	1800	2400	3000	3600	4800	6000
0,065	0,043	0,033	26	46	65	98	130	163	195	260	325	390	520	650	780	1040	1300	1950	2600	3250	3900	5200	6500
0,070	0,047	0,035	28	49	70	105	140	175	210	280	350	420	560	700	840	1120	1400	2100	2800	3500	4200	5600	7000
0,075	0,050	0,038	30	53	75	113	150	188	225	300	375	450	600	750	900	1200	1500	2250	3000	3750	4500	6000	7500
0,080	0,053	0,040	32	56	80	120	160	200	240	320	400	480	640	800	960	1280	1600	2400	3200	4000	4800	6400	8000
0,090	0,060	0,045	36	63	90	135	180	225	270	360	450	540	720	900	1080	1440	1800	2700	3600	4500	5400	7200	9000
0,100	0,067	0,050	40	70	100	150	200	250	300	400	500	600	800	1000	1200	1600	2000	3000	4000	5000	6000	8000	10000
0,110	0,073	0,055	44	77	110	165	220	275	330	440	550	660	880	1100	1320	1760	2200	3300	4400	5500	6600	8800	11000
0,120	0,080	0,060	48	84	120	180	240	300	360	480	600	720	960	1200	1440	1920	2400	3600	4800	6000	7200	9600	12000
0,130	0,087	0,065	52	91	130	195	260	325	390	520	650	780	1040	1300	1560	2080	2600	3900	5200	6500	7800	10400	13000
0,140	0,093	0,070	56	98	140	210	280	350	420	560	700	840	1120	1400	1680	2240	2800	4200	5600	7000	8400	11200	14000
0,150	0,100	0,075	60	105	150	225	300	375	450	600	750	900	1200	1500	1800	2400	3000	4500	6000	7500	9000	12000	15000
0,160	0,107	0,080	64	112	160	240	320	400	480	640	800	960	1280	1600	1920	2560	3200	4800	6400	8000	9600	12800	16000
0,180	0,120	0,090	72	126	180	270	360	450	540	720	900	1080	1440	1800	2160	2880	3600	5400	7200	9000	10800	14400	18000
0,200	0,133	0,100	80	140	200	300	400	500	600	800	1000	1200	1600	2000	2400	3200	4000	6000	8000	10000	12000	16000	20000
0,220	0,147	0,110	88	154	220	330	440	550	660	880	1100	1320	1760	2200	2640	3520	4400	6600	8800	11000	13200	17600	22000
0,240	0,160	0,120	96	168	240	360	480	600	720	960	1200	1440	1920	2400	2880	3840	4800	7200	9600	12000	14400	19200	24000
0,260	0,173	0,130	104	182	260	390	520	650	780	1040	1300	1560	2080	2600	3120	4160	5200	7800	10400	13000	15600	20800	26000
0,280	0,187	0,140	112	196	280	420	560	700	840	1120	1400	1680	2240	2800	3360	4480	5600	8400	11200	14000	16800	22400	28000
0,300	0,200	0,150	120	210	300	450	600	750	900	1200	1500	1800	2400	3000	3600	4800	6000	9000	12000	15000	18000	24000	30000
0,350	0,233	0,175	140	245	350	525	700	875	1050	1400	1750	2100	2800	3500	4200	5600	7000	10500	14000	17500	21000	28000	35000
0,400	0,267	0,200	160	280	400	600	800	1000	1200	1600	2000	2400	3200	4000	4800	6400	8000	12000	16000	20000	24000	32000	40000
0,450	0,300	0,225	180	315	450	675	900	1125	1350	1800	2250	2700	3600	4500	5400	7200	9000	13500	18000	22500	27000	36000	45000
0,500	0,333	0,250	200	350	500	750	1000	1250	1500	2000	2500	3000	4000	5000	6000	8000	10000	15000	20000	25000	30000	40000	50000
0,550	0,367	0,275	220	385	550	825	1100	1375	1650	2200	2750	3300	4400	5500	6600	8800	11000	16500	22000	27500	33000	44000	55000

SIDE MILLING

Roughing

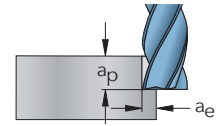

$$a_e = 0,25 \times D$$

$$a_p = 1,0 \times D$$

Carbon Steel, up to 700 N/mm²

D mm	z	a _e mm	a _p mm	V _c m/min	n rpm	F _z mm/z	V _f mm/min
3,0	4	0,75	3,00	130	13 793	0,015	801
4,0	4	1,00	4,00	130	10 345	0,019	801
5,0	4	1,25	5,00	130	8 276	0,027	881
6,0	4	1,50	6,00	130	6 897	0,039	1 068
8,0	4	2,00	8,00	130	5 173	0,054	1 127
10,0	4	2,50	10,00	130	4 138	0,068	1 122
12,0	4	3,00	12,00	130	3 448	0,090	1 235
16,0	4	4,00	16,00	130	2 586	0,119	1 227
20,0	4	5,00	20,00	130	2 069	0,148	1 222
25,0	4	6,25	25,00	130	1 655	0,163	1 082

High Alloy Steel / Hardened Steel HRC 30-45

D mm	z	a _e mm	a _p mm	V _c m/min	n rpm	F _z mm/z	V _f mm/min
3,0	4	0,75	3,00	70	7 427	0,011	314
4,0	4	1,00	4,00	70	5 570	0,014	314
5,0	4	1,25	5,00	70	4 456	0,019	345
6,0	4	1,50	6,00	70	3 714	0,028	418
8,0	4	2,00	8,00	70	2 785	0,040	441
10,0	4	2,50	10,00	70	2 228	0,049	439
12,0	4	3,00	12,00	70	1 857	0,065	484
16,0	4	4,00	16,00	70	1 393	0,086	480
20,0	4	5,00	20,00	70	1 114	0,107	478
25,0	4	6,25	25,00	70	891	0,119	424

Cast Iron, Lamellar Graphite, up to 1000 N/mm²

D mm	z	a _e mm	a _p mm	V _c m/min	n rpm	F _z mm/z	V _f mm/min
3,0	4	0,75	3,00	110	11 671	0,015	678
4,0	4	1,00	4,00	110	8 754	0,019	678
5,0	4	1,25	5,00	110	7 003	0,027	746
6,0	4	1,50	6,00	110	5 836	0,039	904
8,0	4	2,00	8,00	110	4 377	0,054	953
10,0	4	2,50	10,00	110	3 501	0,068	949
12,0	4	3,00	12,00	110	2 918	0,090	1 045
16,0	4	4,00	16,00	110	2 188	0,119	1 038
20,0	4	5,00	20,00	110	1 751	0,148	1 034
25,0	4	6,25	25,00	110	1 401	0,163	915

Copper, Unalloyed

D mm	z	a _e mm	a _p mm	V _c m/min	n rpm	F _z mm/z	V _f mm/min
3,0	4	0,75	3,00	170	18 038	0,013	952
4,0	4	1,00	4,00	170	13 528	0,018	952
5,0	4	1,25	5,00	170	10 823	0,024	1 048
6,0	4	1,50	6,00	170	9 019	0,035	1 270
8,0	4	2,00	8,00	170	6 764	0,050	1 339
10,0	4	2,50	10,00	170	5 411	0,062	1 333
12,0	4	3,00	12,00	170	4 509	0,081	1 468
16,0	4	4,00	16,00	170	3 382	0,108	1 458
20,0	4	5,00	20,00	170	2 706	0,134	1 452
25,0	4	6,25	25,00	170	2 165	0,149	1 286

Stainless Steel, Austenitic

D mm	z	a _e mm	a _p mm	V _c m/min	n rpm	F _z mm/z	V _f mm/min
3,0	3	0,75	3,00	100	10 610	0,012	504
4,0	3	1,00	4,00	100	7 958	0,016	504
5,0	3	1,25	5,00	100	6 366	0,022	555
6,0	3	1,50	6,00	100	5 305	0,032	672
8,0	3	2,00	8,00	100	3 979	0,045	709
10,0	3	2,50	10,00	100	3 183	0,055	706
12,0	3	3,00	12,00	100	2 653	0,073	777
16,0	3	4,00	16,00	100	1 989	0,097	772
20,0	3	5,00	20,00	100	1 592	0,121	769

Aluminium, up to 10% Si

D mm	z	a _e mm	a _p mm	V _c m/min	n rpm	F _z mm/z	V _f mm/min
3,0	2	0,75	3,00	300	31 831	0,016	2 017
4,0	2	1,00	4,00	300	23 873	0,021	2 017
5,0	2	1,25	5,00	300	19 099	0,029	2 218
6,0	2	1,50	6,00	300	15 916	0,042	2 689
8,0	2	2,00	8,00	300	11 937	0,059	2 836
10,0	2	2,50	10,00	300	9 549	0,074	2 824
12,0	2	3,00	12,00	300	7 958	0,098	3 109
16,0	2	4,00	16,00	300	5 968	0,129	3 088
20,0	2	5,00	20,00	300	4 775	0,161	3 076

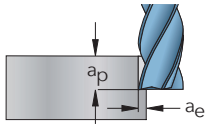

SIDE MILLING

Finishing



$$a_e = 0,1 \times D$$

$$a_p = 1,5 \times D$$

Carbon Steel, up to 700 N/mm²

D mm	z	a _e mm	a _p mm	V _c m/min	n rpm	F _z mm/z	V _f mm/min
3,0	4	0,30	4,50	150	15 916	0,018	1 176
4,0	4	0,40	6,00	150	11 937	0,025	1 176
5,0	4	0,50	7,50	150	9 549	0,034	1 294
6,0	4	0,60	9,00	150	7 958	0,049	1 569
8,0	4	0,80	12,00	150	5 968	0,069	1 654
10,0	4	1,00	15,00	150	4 775	0,086	1 647
	6	1,00	15,00	150	4 775	0,086	2 471
12,0	4	1,20	18,00	150	3 979	0,114	1 814
	6	1,20	18,00	150	3 979	0,114	2 721
16,0	4	1,60	24,00	150	2 984	0,151	1 801
	6	1,60	24,00	150	2 984	0,151	2 702
20,0	4	2,00	30,00	150	2 387	0,188	1 794
	6	2,00	30,00	150	2 387	0,188	2 691
25,0	4	2,50	37,50	150	1 910	0,208	1 588
	6	2,50	37,50	150	1 910	0,208	2 382
32,0	8	3,20	48,00	150	1 492	0,223	2 665
40,0	10	4,00	60,00	150	1 194	0,239	2 849

High Alloy Steel / Hardened Steel HRC 30-45

D mm	z	a _e mm	a _p mm	V _c m/min	n rpm	F _z mm/z	V _f mm/min
3,0	4	0,30	4,50	90	9 549	0,013	513
4,0	4	0,40	6,00	90	7 162	0,018	513
5,0	4	0,50	7,50	90	5 730	0,025	565
6,0	4	0,60	9,00	90	4 775	0,036	684
8,0	4	0,80	12,00	90	3 581	0,050	722
10,0	4	1,00	15,00	90	2 865	0,063	719
	6	1,00	15,00	90	2 865	0,063	1 078
12,0	4	1,20	18,00	90	2 387	0,083	791
	6	1,20	18,00	90	2 387	0,083	1 187
16,0	4	1,60	24,00	90	1 790	0,110	786
	6	1,60	24,00	90	1 790	0,110	1 179
20,0	4	2,00	30,00	90	1 432	0,137	783
	6	2,00	30,00	90	1 432	0,137	1 174
25,0	4	2,50	37,50	90	1 146	0,151	693
	6	2,50	37,50	90	1 146	0,151	1 040
32,0	8	3,20	48,00	90	895	0,162	1 163
40,0	10	4,00	60,00	90	716	0,174	1 243

Cast Iron, Lamellar Graphite, up to 1000 N/mm²

D mm	z	a _e mm	a _p mm	V _c m/min	n rpm	F _z mm/z	V _f mm/min
6,0	6	0,60	9,00	130	6 897	0,049	2 039
8,0	6	0,80	12,00	130	5 173	0,069	2 151
10,0	6	1,00	15,00	130	4 138	0,086	2 141
12,0	6	1,20	18,00	130	3 448	0,114	2 358
16,0	6	1,60	24,00	130	2 586	0,151	2 342
20,0	6	2,00	30,00	130	2 069	0,188	2 332
25,0	8	2,50	37,50	130	1 655	0,208	2 753
32,0	8	3,20	48,00	130	1 293	0,223	2 310
40,0	10	4,00	60,00	130	1 035	0,239	2 469

Copper, Unalloyed

D mm	z	a _e mm	a _p mm	V _c m/min	n rpm	F _z mm/z	V _f mm/min
4,0	4	0,40	6,00	200	15 916	0,022	1 426
5,0	4	0,50	7,50	200	12 732	0,031	1 569
6,0	4	0,60	9,00	200	10 610	0,045	1 901
8,0	4	0,80	12,00	200	7 958	0,063	2 005
10,0	4	1,00	15,00	200	6 366	0,078	1 996
12,0	4	1,20	18,00	200	5 305	0,104	2 198
16,0	4	1,60	24,00	200	3 979	0,137	2 184
20,0	4	2,00	30,00	200	3 183	0,171	2 175
25,0	4	2,50	37,50	200	2 546	0,189	1 925

Hardened Steel HRC 45-55

D mm	z	a _e mm	a _p mm	V _c m/min	n rpm	F _z mm/z	V _f mm/min
6,0	6	0,60	9,00	45	2 387	0,031	449
8,0	6	0,80	12,00	45	1 790	0,044	474
10,0	6	1,00	15,00	45	1 432	0,055	472
12,0	6	1,20	18,00	45	1 194	0,073	519
16,0	6	1,60	24,00	45	895	0,096	516
20,0	6	2,00	30,00	45	716	0,120	514
25,0	8	2,50	37,50	45	573	0,132	606
32,0	8	3,20	48,00	45	448	0,142	509
40,0	10	4,00	60,00	45	358	0,152	544

Hardened Steel HRC 55-65

D mm	z	a _e mm	a _p mm	V _c m/min	n rpm	F _z mm/z	V _f mm/min
6,0	6	0,60	9,00	30	1 592	0,027	257
8,0	6	0,80	12,00	30	1 194	0,038	271
10,0	6	1,00	15,00	30	955	0,047	270
12,0	6	1,20	18,00	30	796	0,062	297
16,0	6	1,60	24,00	30	597	0,082	295
20,0	6	2,00	30,00	30	477	0,102	294
25,0	8	2,50	37,50	30	382	0,113	347
32,0	8	3,20	48,00	30	298	0,122	291
40,0	10	4,00	60,00	30	239	0,130	311

Stainless Steel, Austenitic

D mm	z	a _e mm	a _p mm	V _c m/min	n rpm	F _z mm/z	V _f mm/min
3,0	3	0,30	4,50	120	12 732	0,015	578
4,0	3	0,40	6,00	120	9 549	0,020	578
5,0	3	0,50	7,50	120	7 639	0,028	635
6,0	3	0,60	9,00	120	6 366	0,040	770
8,0	3	0,80	12,00	120	4 775	0,057	812
10,0	3	1,00	15,00	120	3 820	0,071	809
12,0	3	1,20	18,00	120	3 183	0,093	890
16,0	3	1,60	24,00	120	2 387	0,123	884
20,0	3	2,00	30,00	120	1 910	0,154	881

Aluminium, up to 10% Si

D mm	z	a _e mm	a _p mm	V _c m/min	n rpm	F _z mm/z	V _f mm/min
3,0	2	0,30	4,50	350	37 136	0,020	1 497
4,0	2	0,40	6,00	350	27 852	0,027	1 497
5,0	2	0,50	7,50	350	22 282	0,037	1 647
6,0	2	0,60	9,00	350	18 568	0,054	1 996
8,0	2	0,80	12,00	350	13 926	0,076	2 106
10,0	2	1,00	15,00	350	11 141	0,094	2 096
12,0	2	1,20	18,00	350	9 284	0,124	2 308
16,0	2	1,60	24,00	350	6 963	0,165	2 293
20,0	2	2,00	30,00	350	5 570	0,205	2 283

SLOT MILLING

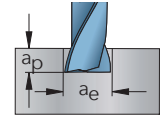

$$a_e = 1,0 \times D$$

$$a_p = 0,5 \times D$$

Carbon Steel, up to 700 N/mm²

D mm	z	a _e mm	a _p mm	V _c m/min	n rpm	F _z mm/z	V _f mm/min
0,5	2	0,50	0,25	130	82 761	0,003	510
1,0	2	1,00	0,50	130	41 380	0,005	382
	3	1,00	0,50	130	41 380	0,005	574
1,5	2	1,50	0,75	130	27 587	0,006	319
	3	1,50	0,75	130	27 587	0,006	478
2,0	2	2,00	1,00	130	20 690	0,007	287
	3	2,00	1,00	130	20 690	0,007	430
2,5	2	2,50	1,25	130	16 552	0,008	268
	3	2,50	1,25	130	16 552	0,008	401
3,0	2	3,00	1,50	130	13 793	0,009	255
	3	3,00	1,50	130	13 793	0,009	382
4,0	2	4,00	2,00	130	10 345	0,012	255
	3	4,00	2,00	130	10 345	0,012	382
5,0	2	5,00	2,50	130	8 276	0,017	280
	3	5,00	2,50	130	8 276	0,017	421
6,0	2	6,00	3,00	130	6 897	0,025	340
	3	6,00	3,00	130	6 897	0,025	510
8,0	2	8,00	4,00	130	5 173	0,035	358
	3	8,00	4,00	130	5 173	0,035	538
10,0	2	10,00	5,00	130	4 138	0,043	357
	3	10,00	5,00	130	4 138	0,043	535
12,0	2	12,00	6,00	130	3 448	0,057	393
	3	12,00	6,00	130	3 448	0,057	589
14,0	2	14,00	7,00	130	2 956	0,066	391
	3	14,00	7,00	130	2 956	0,066	587
16,0	2	16,00	8,00	130	2 586	0,075	390
	3	16,00	8,00	130	2 586	0,075	585
18,0	2	18,00	9,00	130	2 299	0,085	389
	3	18,00	9,00	130	2 299	0,085	584
20,0	2	20,00	10,00	130	2 069	0,094	389
	3	20,00	10,00	130	2 069	0,094	583
25,0	2	25,00	12,50	130	1 655	0,104	344
	3	25,00	12,50	130	1 655	0,104	516

High Alloy Steel / Hardened Steel HRC 30-45

D mm	z	a _e mm	a _p mm	V _c m/min	n rpm	F _z mm/z	V _f mm/min
0,5	2	0,50	0,25	70	44 563	0,002	200
1,0	2	1,00	0,50	70	22 282	0,003	150
	3	1,00	0,50	70	22 282	0,003	225
1,5	2	1,50	0,75	70	14 854	0,004	125
	3	1,50	0,75	70	14 854	0,004	187
2,0	2	2,00	1,00	70	11 141	0,005	112
	3	2,00	1,00	70	11 141	0,005	168
2,5	2	2,50	1,25	70	8 913	0,006	105
	3	2,50	1,25	70	8 913	0,006	157
3,0	2	3,00	1,50	70	7 427	0,007	100
	3	3,00	1,50	70	7 427	0,007	150
4,0	2	4,00	2,00	70	5 570	0,009	100
	3	4,00	2,00	70	5 570	0,009	150
5,0	2	5,00	2,50	70	4 456	0,012	110
	3	5,00	2,50	70	4 456	0,012	165
6,0	2	6,00	3,00	70	3 714	0,018	133
	3	6,00	3,00	70	3 714	0,018	200
8,0	2	8,00	4,00	70	2 785	0,025	140
	3	8,00	4,00	70	2 785	0,025	211
10,0	2	10,00	5,00	70	2 228	0,031	140
	3	10,00	5,00	70	2 228	0,031	210
12,0	2	12,00	6,00	70	1 857	0,041	154
	3	12,00	6,00	70	1 857	0,041	231
14,0	2	14,00	7,00	70	1 592	0,048	153
	3	14,00	7,00	70	1 592	0,048	230
16,0	2	16,00	8,00	70	1 393	0,055	153
	3	16,00	8,00	70	1 393	0,055	229
18,0	2	18,00	9,00	70	1 238	0,062	153
	3	18,00	9,00	70	1 238	0,062	229
20,0	2	20,00	10,00	70	1 114	0,068	152
	3	20,00	10,00	70	1 114	0,068	228
25,0	2	25,00	12,50	70	891	0,076	135
	3	25,00	12,50	70	891	0,076	202

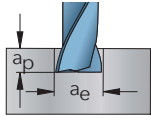

SLOT MILLING

$$a_e = 1,0 \times D$$

$$a_p = 0,5 \times D$$

Cast Iron, Lamellar Graphite, up to 1000 N/mm²

D mm	z	a _e mm	a _p mm	V _c m/min	n rpm	F _z mm/z	V _f mm/min
0,5	2	0,50	0,25	110	70 028	0,003	431
1,0	2	1,00	0,50	110	35 014	0,005	324
	3	1,00	0,50	110	35 014	0,005	485
1,5	2	1,50	0,75	110	23 343	0,006	270
	3	1,50	0,75	110	23 343	0,006	404
2,0	2	2,00	1,00	110	17 507	0,007	243
	3	2,00	1,00	110	17 507	0,007	364
2,5	2	2,50	1,25	110	14 006	0,008	226
	3	2,50	1,25	110	14 006	0,008	340
3,0	2	3,00	1,50	110	11 671	0,009	216
	3	3,00	1,50	110	11 671	0,009	324
4,0	2	4,00	2,00	110	8 754	0,012	216
	3	4,00	2,00	110	8 754	0,012	324
5,0	2	5,00	2,50	110	7 003	0,017	237
	3	5,00	2,50	110	7 003	0,017	356
6,0	2	6,00	3,00	110	5 836	0,025	288
	3	6,00	3,00	110	5 836	0,025	431
8,0	2	8,00	4,00	110	4 377	0,035	303
	3	8,00	4,00	110	4 377	0,035	455
10,0	2	10,00	5,00	110	3 501	0,043	302
	3	10,00	5,00	110	3 501	0,043	453
12,0	2	12,00	6,00	110	2 918	0,057	333
	3	12,00	6,00	110	2 918	0,057	499
14,0	2	14,00	7,00	110	2 501	0,066	331
	3	14,00	7,00	110	2 501	0,066	497
16,0	2	16,00	8,00	110	2 188	0,075	330
	3	16,00	8,00	110	2 188	0,075	495
18,0	2	18,00	9,00	110	1 945	0,085	330
	3	18,00	9,00	110	1 945	0,085	494
20,0	2	20,00	10,00	110	1 751	0,094	329
	3	20,00	10,00	110	1 751	0,094	493
25,0	2	25,00	12,50	110	1 401	0,104	291
	3	25,00	12,50	110	1 401	0,104	437

Copper, Unalloyed

D mm	z	a _e mm	a _p mm	V _c m/min	n rpm	F _z mm/z	V _f mm/min
0,5	2	0,50	0,25	170	108 225	0,003	606
1,0	2	1,00	0,50	170	54 113	0,004	455
	3	1,00	0,50	170	54 113	0,004	682
1,5	2	1,50	0,75	170	36 075	0,005	379
	3	1,50	0,75	170	36 075	0,005	568
2,0	2	2,00	1,00	170	27 056	0,006	341
	3	2,00	1,00	170	27 056	0,006	511
2,5	2	2,50	1,25	170	21 645	0,007	318
	3	2,50	1,25	170	21 645	0,007	477
3,0	2	3,00	1,50	170	18 038	0,008	303
	3	3,00	1,50	170	18 038	0,008	455
4,0	2	4,00	2,00	170	13 528	0,011	303
	3	4,00	2,00	170	13 528	0,011	455
5,0	2	5,00	2,50	170	10 823	0,015	333
	3	5,00	2,50	170	10 823	0,015	500
6,0	2	6,00	3,00	170	9 019	0,022	404
	3	6,00	3,00	170	9 019	0,022	606
8,0	2	8,00	4,00	170	6 764	0,032	426
	3	8,00	4,00	170	6 764	0,032	639
10,0	2	10,00	5,00	170	5 411	0,039	424
	3	10,00	5,00	170	5 411	0,039	636
12,0	2	12,00	6,00	170	4 509	0,052	467
	3	12,00	6,00	170	4 509	0,052	701
14,0	2	14,00	7,00	170	3 865	0,060	465
	3	14,00	7,00	170	3 865	0,060	698
16,0	2	16,00	8,00	170	3 382	0,069	464
	3	16,00	8,00	170	3 382	0,069	696
18,0	2	18,00	9,00	170	3 006	0,077	463
	3	18,00	9,00	170	3 006	0,077	694
20,0	2	20,00	10,00	170	2 706	0,085	462
	3	20,00	10,00	170	2 706	0,085	693
25,0	2	25,00	12,50	170	2 165	0,095	409
	3	25,00	12,50	170	2 165	0,095	614

Stainless Steel, Austenitic

D mm	z	a _e mm	a _p mm	V _c m/min	n rpm	F _z mm/z	V _f mm/min
3,0	3	3,00	1,50	100	10 610	0,008	241
4,0	3	4,00	2,00	100	7 958	0,010	241
5,0	3	5,00	2,50	100	6 366	0,014	265
6,0	3	6,00	3,00	100	5 305	0,020	321
8,0	3	8,00	4,00	100	3 979	0,028	338
10,0	3	10,00	5,00	100	3 183	0,035	337
12,0	3	12,00	6,00	100	2 653	0,047	371
16,0	3	16,00	8,00	100	1 989	0,062	368
20,0	3	20,00	10,00	100	1 592	0,077	367

Aluminium, up to 10% Si

D mm	z	a _e mm	a _p mm	V _c m/min	n rpm	F _z mm/z	V _f mm/min
3,0	2	3,00	1,50	300	31 831	0,010	963
4,0	2	4,00	2,00	300	23 873	0,013	963
5,0	2	5,00	2,50	300	19 099	0,018	1 059
6,0	2	6,00	3,00	300	15 916	0,027	1 283
8,0	2	8,00	4,00	300	11 937	0,038	1 354
10,0	2	10,00	5,00	300	9 549	0,047	1 348
12,0	2	12,00	6,00	300	7 958	0,062	1 484
16,0	2	16,00	8,00	300	5 968	0,082	1 474
20,0	2	20,00	10,00	300	4 775	0,102	1 468

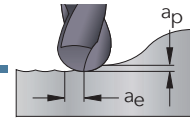

$$a_e = 0,3 \times D$$

$$a_p = 0,1 \times D$$

High Alloy Steel / Hardened Steel HRC 30-45

D	z	a _e	a _p	V _c	n	F _z	V _f
mm		mm	mm	m/min	rpm	mm/z	mm/min
0,3	2	0,09	0,03	47	50 000	0,005	500
0,4	2	0,12	0,04	63	50 000	0,007	700
0,5	2	0,15	0,05	79	50 000	0,009	900
0,6	2	0,18	0,06	94	50 000	0,010	1 000
0,7	2	0,21	0,07	110	50 000	0,012	1 200
0,8	2	0,24	0,08	126	50 000	0,014	1 400
1,0	2	0,30	0,10	157	50 000	0,018	1 800
1,2	2	0,36	0,12	188	50 000	0,021	2 100
1,5	2	0,45	0,15	236	50 000	0,027	2 700
2,0	2	0,60	0,20	300	47 747	0,035	3 342
2,5	2	0,75	0,25	300	38 197	0,047	3 591
3,0	2	0,90	0,30	300	31 831	0,064	4 074
4,0	2	1,20	0,40	300	23 873	0,082	3 915
5,0	2	1,50	0,50	300	19 099	0,102	3 896
6,0	2	1,80	0,60	300	15 916	0,121	3 852
8,0	2	2,40	0,80	300	11 937	0,138	3 295
10,0	2	3,00	1,00	300	9 549	0,152	2 903
12,0	2	3,60	1,20	300	7 958	0,163	2 594
16,0	2	4,80	1,60	300	5 968	0,181	2 161

Hardened Steel HRC 45-55

D	z	a _e	a _p	V _c	n	F _z	V _f
mm		mm	mm	m/min	rpm	mm/z	mm/min
0,3	2	0,09	0,03	47	50 000	0,004	440
0,4	2	0,12	0,04	63	50 000	0,006	616
0,5	2	0,15	0,05	79	50 000	0,008	792
0,6	2	0,18	0,06	94	50 000	0,009	880
0,7	2	0,21	0,07	110	50 000	0,011	1 056
0,8	2	0,24	0,08	126	50 000	0,012	1 232
1,0	2	0,30	0,10	157	50 000	0,016	1 584
1,2	2	0,36	0,12	188	50 000	0,018	1 848
1,5	2	0,45	0,15	236	50 000	0,024	2 376
2,0	2	0,60	0,20	250	39 789	0,031	2 451
2,5	2	0,75	0,25	250	31 831	0,041	2 633
3,0	2	0,90	0,30	250	26 526	0,056	2 988
4,0	2	1,20	0,40	250	19 894	0,072	2 871
5,0	2	1,50	0,50	250	15 916	0,090	2 857
6,0	2	1,80	0,60	250	13 263	0,106	2 824
8,0	2	2,40	0,80	250	9 947	0,121	2 416
10,0	2	3,00	1,00	250	7 958	0,134	2 129
12,0	2	3,60	1,20	250	6 631	0,143	1 902
16,0	2	4,80	1,60	250	4 974	0,159	1 584

Hardened Steel HRC 55-65

D	z	a _e	a _p	V _c	n	F _z	V _f
mm		mm	mm	m/min	rpm	mm/z	mm/min
0,3	2	0,09	0,03	47	50 000	0,004	410
0,4	2	0,12	0,04	63	50 000	0,006	574
0,5	2	0,15	0,05	79	50 000	0,007	738
0,6	2	0,18	0,06	94	50 000	0,008	820
0,7	2	0,21	0,07	110	50 000	0,010	984
0,8	2	0,24	0,08	126	50 000	0,011	1 148
1,0	2	0,30	0,10	157	50 000	0,015	1 476
1,2	2	0,36	0,12	188	50 000	0,017	1 722
1,5	2	0,45	0,15	200	42 441	0,022	1 879
2,0	2	0,60	0,20	200	31 831	0,029	1 827
2,5	2	0,75	0,25	200	25 465	0,039	1 963
3,0	2	0,90	0,30	200	21 221	0,052	2 227
4,0	2	1,20	0,40	200	15 916	0,067	2 140
5,0	2	1,50	0,50	200	12 732	0,084	2 130
6,0	2	1,80	0,60	200	10 610	0,099	2 106
8,0	2	2,40	0,80	200	7 958	0,113	1 801
10,0	2	3,00	1,00	200	6 366	0,125	1 587
12,0	2	3,60	1,20	200	5 305	0,134	1 418
16,0	2	4,80	1,60	200	3 979	0,148	1 181

Graphite

D	z	a _e	a _p	V _c	n	F _z	V _f
mm		mm	mm	m/min	rpm	mm/z	mm/min
0,3	2	0,09	0,03	47	50 000	0,006	625
0,4	2	0,12	0,04	63	50 000	0,009	875
0,5	2	0,15	0,05	79	50 000	0,011	1 125
0,6	2	0,18	0,06	94	50 000	0,013	1 250
0,7	2	0,21	0,07	110	50 000	0,015	1 500
0,8	2	0,24	0,08	126	50 000	0,018	1 750
1,0	2	0,30	0,10	157	50 000	0,023	2 250
1,2	2	0,36	0,12	188	50 000	0,026	2 625
1,5	2	0,45	0,15	236	50 000	0,034	3 375
2,0	2	0,60	0,20	314	50 000	0,044	4 375
2,5	2	0,75	0,25	393	50 000	0,059	5 875
3,0	2	0,90	0,30	400	42 441	0,080	6 791
4,0	2	1,20	0,40	400	31 831	0,103	6 525
5,0	2	1,50	0,50	400	25 465	0,128	6 494
6,0	2	1,80	0,60	400	21 221	0,151	6 419
8,0	2	2,40	0,80	400	15 916	0,173	5 491
10,0	2	3,00	1,00	400	12 732	0,190	4 838
12,0	2	3,60	1,20	400	10 610	0,204	4 324
16,0	2	4,80	1,60	400	7 958	0,226	3 601

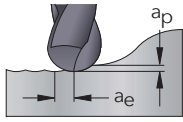

HIGH SPEED CUTTING

Finishing



$$a_e = 0,05 \times D$$

$$a_p = 0,05 \times D$$

High Alloy Steel / Hardened Steel HRC 30-45

D	z	a _e	a _p	V _c	n	F _z	V _f
mm		mm	mm	m/min	rpm	mm/z	mm/min
0,3	2	0,02	0,02	47	50 000	0,006	600
0,4	2	0,02	0,02	63	50 000	0,008	840
0,5	2	0,03	0,03	79	50 000	0,011	1 080
0,6	2	0,03	0,03	94	50 000	0,012	1 200
0,7	2	0,04	0,04	110	50 000	0,014	1 440
0,8	2	0,04	0,04	126	50 000	0,017	1 680
1,0	2	0,05	0,05	157	50 000	0,022	2 160
1,2	2	0,06	0,06	188	50 000	0,025	2 520
1,5	2	0,08	0,08	236	50 000	0,032	3 240
2,0	2	0,10	0,10	314	50 000	0,042	4 200
2,5	2	0,13	0,13	350	44 563	0,056	5 027
3,0	2	0,15	0,15	350	37 136	0,077	5 704
4,0	2	0,20	0,20	350	27 852	0,098	5 481
5,0	2	0,25	0,25	350	22 282	0,122	5 455
6,0	2	0,30	0,30	350	18 568	0,145	5 392
8,0	2	0,40	0,40	350	13 926	0,166	4 612
10,0	2	0,50	0,50	350	11 141	0,182	4 064
12,0	2	0,60	0,60	350	9 284	0,196	3 632
16,0	2	0,80	0,80	350	6 963	0,217	3 025

Hardened Steel HRC 45-55

D	z	a _e	a _p	V _c	n	F _z	V _f
mm		mm	mm	m/min	rpm	mm/z	mm/min
0,3	2	0,02	0,02	47	50 000	0,005	528
0,4	2	0,02	0,02	63	50 000	0,007	739
0,5	2	0,03	0,03	79	50 000	0,010	950
0,6	2	0,03	0,03	94	50 000	0,011	1 056
0,7	2	0,04	0,04	110	50 000	0,013	1 267
0,8	2	0,04	0,04	126	50 000	0,015	1 478
1,0	2	0,05	0,05	157	50 000	0,019	1 901
1,2	2	0,06	0,06	188	50 000	0,022	2 218
1,5	2	0,08	0,08	236	50 000	0,029	2 851
2,0	2	0,10	0,10	300	47 747	0,037	3 529
2,5	2	0,13	0,13	300	38 197	0,050	3 792
3,0	2	0,15	0,15	300	31 831	0,068	4 303
4,0	2	0,20	0,20	300	23 873	0,087	4 134
5,0	2	0,25	0,25	300	19 099	0,108	4 114
6,0	2	0,30	0,30	300	15 916	0,128	4 067
8,0	2	0,40	0,40	300	11 937	0,146	3 479
10,0	2	0,50	0,50	300	9 549	0,161	3 066
12,0	2	0,60	0,60	300	7 958	0,172	2 740
16,0	2	0,80	0,80	300	5 968	0,191	2 282

Hardened Steel HRC 55-65

D	z	a _e	a _p	V _c	n	F _z	V _f
mm		mm	mm	m/min	rpm	mm/z	mm/min
0,3	2	0,02	0,02	47	50 000	0,005	492
0,4	2	0,02	0,02	63	50 000	0,007	689
0,5	2	0,03	0,03	79	50 000	0,009	886
0,6	2	0,03	0,03	94	50 000	0,010	984
0,7	2	0,04	0,04	110	50 000	0,012	1 181
0,8	2	0,04	0,04	126	50 000	0,014	1 378
1,0	2	0,05	0,05	157	50 000	0,018	1 771
1,2	2	0,06	0,06	188	50 000	0,021	2 066
1,5	2	0,08	0,08	236	50 000	0,027	2 657
2,0	2	0,10	0,10	250	39 789	0,034	2 741
2,5	2	0,13	0,13	250	31 831	0,046	2 944
3,0	2	0,15	0,15	250	26 526	0,063	3 341
4,0	2	0,20	0,20	250	19 894	0,081	3 210
5,0	2	0,25	0,25	250	15 916	0,100	3 195
6,0	2	0,30	0,30	250	13 263	0,119	3 158
8,0	2	0,40	0,40	250	9 947	0,136	2 701
10,0	2	0,50	0,50	250	7 958	0,150	2 380
12,0	2	0,60	0,60	250	6 631	0,160	2 127
16,0	2	0,80	0,80	250	4 974	0,178	1 772

Graphite

D	z	a _e	a _p	V _c	n	F _z	V _f
mm		mm	mm	m/min	rpm	mm/z	mm/min
0,3	2	0,02	0,02	47	50 000	0,008	750
0,4	2	0,02	0,02	63	50 000	0,011	1 050
0,5	2	0,03	0,03	79	50 000	0,014	1 350
0,6	2	0,03	0,03	94	50 000	0,015	1 500
0,7	2	0,04	0,04	110	50 000	0,018	1 800
0,8	2	0,04	0,04	126	50 000	0,021	2 100
1,0	2	0,05	0,05	157	50 000	0,027	2 700
1,2	2	0,06	0,06	188	50 000	0,032	3 150
1,5	2	0,08	0,08	236	50 000	0,041	4 050
2,0	2	0,10	0,10	314	50 000	0,053	5 250
2,5	2	0,13	0,13	393	50 000	0,071	7 050
3,0	2	0,15	0,15	450	47 747	0,096	9 167
4,0	2	0,20	0,20	450	35 810	0,123	8 809
5,0	2	0,25	0,25	450	28 648	0,153	8 766
6,0	2	0,30	0,30	450	23 873	0,182	8 666
8,0	2	0,40	0,40	450	17 905	0,207	7 413
10,0	2	0,50	0,50	450	14 324	0,228	6 532
12,0	2	0,60	0,60	450	11 937	0,245	5 837
16,0	2	0,80	0,80	450	8 952	0,272	4 861

Two Flute

LC
AlCrN coated
Super Micrograin Carbide
Tolerance
D 1,0 - 5,0 +0 / -0,020
D 6,0 - 7,0 +0 / -0,025
D 8,0 - 9,0 +0 / -0,030
D 10,0 - 12,0 +0 / -0,035
Shank
Cylindrical h6, DIN6535 HA
Flute
35° right hand spiral, center cutting
Field of application
All types of steel up to HRC55

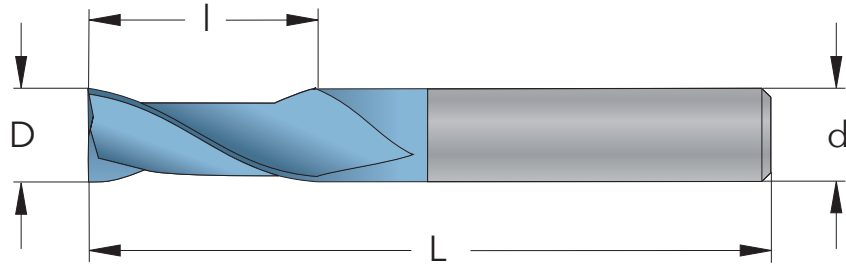

D mm	d mm	Part Number	l mm	L mm	No. of Flutes
1,0	4	M0401B3_LC	3	50	2
1,5	4	M04015B4_LC	4	50	2
2,0	4	M0402B6_LC	6	50	2
2,5	4	M04025B8_LC	8	50	2
3,0	4	M0403B8_LC	8	50	2
3,0	6	M0603B8_LC	8	57	2
4,0	4	M0404B11_LC	11	50	2
4,0	6	M0604B11_LC	11	57	2
5,0	6	M0605B13_LC	13	57	2
6,0	6	M0606B16_LC	16	57	2
8,0	8	M0808B20_LC	20	63	2
10,0	10	M1010B25_LC	25	72	2
12,0	12	M1212B30_LC	30	83	2



Three Flute

LC

AlCrN coated

Super Micrograin Carbide

Tolerance

D 1,0 - 5,0 +0 / -0,020

D 6,0 - 7,0 +0 / -0,025

D 8,0 - 9,0 +0 / -0,030

D 10,0 - 12,0 +0 / -0,035

Shank

Cylindrical h6, DIN6535 HA

Flute

35° right hand spiral, center cutting

Field of application

All types of steel up to HRC55

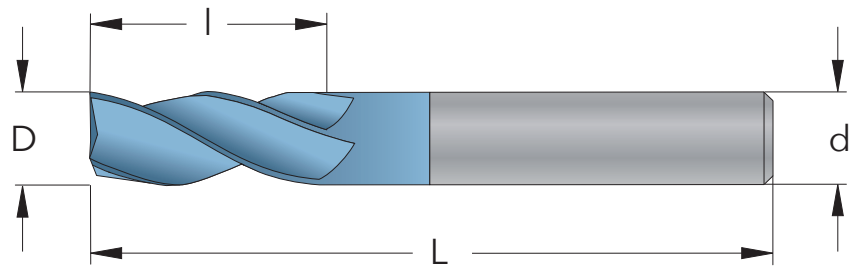

D mm	d mm	Part Number	l mm	L mm	No. of Flutes
1,0	4	M0401C3_LC	3	50	3
1,5	4	M04015C4_LC	4	50	3
2,0	4	M0402C6_LC	6	50	3
2,5	4	M04025C8_LC	8	50	3
3,0	4	M0403C8_LC	8	50	3
3,0	6	M0603C8_LC	8	57	3
4,0	4	M0404C11_LC	11	50	3
4,0	6	M0604C11_LC	11	57	3
5,0	6	M0605C13_LC	13	57	3
6,0	6	M0606C10_LC	10	50	3
6,0	6	M0606C16_LC	16	57	3
8,0	8	M0808C12_LC	12	57	3
8,0	8	M0808C20_LC	20	63	3
10,0	10	M1010C15_LC	15	63	3
10,0	10	M1010C25_LC	25	72	3
12,0	12	M1212C18_LC	18	72	3
12,0	12	M1212C30_LC	30	83	3



Four Flute

LC
AlCrN coated
Super Micrograin Carbide
Tolerance

D 1,0 - 5,0 +0 / -0,020
D 6,0 - 7,0 +0 / -0,025
D 8,0 - 9,0 +0 / -0,030
D 10,0 - 12,0 +0 / -0,035
D 16,0 - 20,0 +0 / -0,040

Shank
Cylindrical h6, DIN6535 HA

Flute
35° right hand spiral, center cutting

Field of application
All types of steel up to HRC55

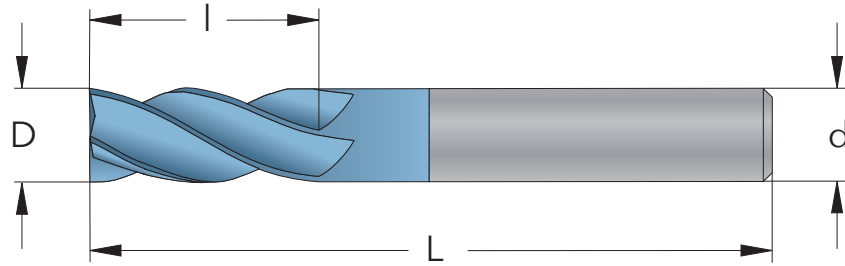

D mm	d mm	Part Number	l mm	L mm	No. of Flutes
2,0	4	M0402D6_LC	6	50	4
3,0	4	M0403D8_LC	8	50	4
3,0	6	M0603D8_LC	8	57	4
4,0	4	M0404D11_LC	11	50	4
4,0	6	M0604D11_LC	11	57	4
5,0	6	M0605D13_LC	13	57	4
6,0	6	M0606D10_LC	10	50	4
6,0	6	M0606D16_LC	16	57	4
6,0	6	M0606D26_LC	26	72	4
7,0	8	M0807D18_LC	18	63	4
8,0	8	M0808D12_LC	12	57	4
8,0	8	M0808D20_LC	20	63	4
8,0	8	M0808D32_LC	32	83	4
10,0	10	M1010D15_LC	15	63	4
10,0	10	M1010D25_LC	25	72	4
10,0	10	M1010D40_LC	40	92	4
12,0	12	M1212D18_LC	18	72	4
12,0	12	M1212D30_LC	30	83	4
12,0	12	M1212D48_LC	48	100	4
16,0	16	M1616D34_LC	34	92	4
20,0	20	M2020D40_LC	40	100	4

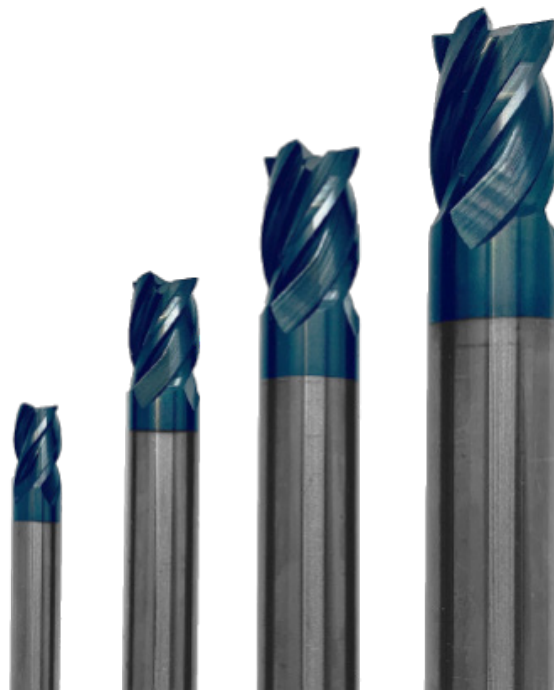

Two Flute, with Ball Nose

LC

AlCrN coated

Super Micrograin Carbide

Tolerance

D 1,0 - 5,0 +0 / -0,020

D 6,0 - 7,0 +0 / -0,025

D 8,0 - 9,0 +0 / -0,030

D 10,0 - 12,0 +0 / -0,035

Shank

Cylindrical h6, DIN6535 HA

Flute

35° right hand spiral, center cutting

Field of application

All types of steel up to HRC55

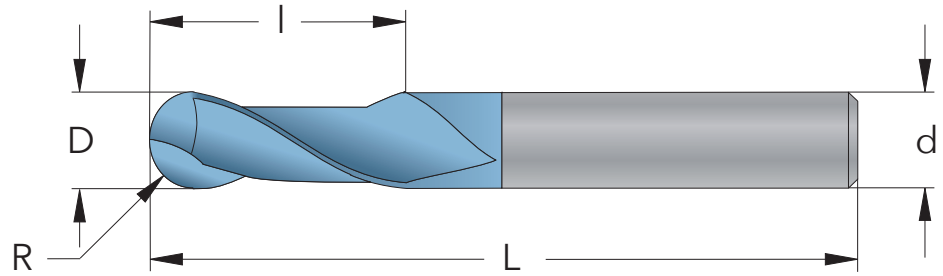

D mm	d mm	R mm	Part Number	l mm	L mm	No. of Flutes
1,0	4	0,5	R0401B2_LC	2	50	2
1,5	4	0,75	R04015B3_LC	3	50	2
2,0	4	1,0	R0402B4_LC	4	50	2
2,5	4	1,25	R04025B5_LC	5	50	2
3,0	4	1,5	R0403B6_LC	6	50	2
3,0	6	1,5	R0603B6_LC	6	57	2
4,0	4	2,0	R0404B8_LC	8	50	2
4,0	6	2,0	R0604B8_LC	8	57	2
5,0	6	2,5	R0605B10_LC	10	57	2
6,0	6	3,0	R0606B12_LC	12	57	2
8,0	8	4,0	R0808B16_LC	16	63	2
10,0	10	5,0	R1010B20_LC	20	72	2
12,0	12	6,0	R1212B24_LC	24	83	2



Variable Flute 35° and 38°

LC
AlCrN coated
Super Micrograin Carbide
Tolerance
D 6,0 - 7,0 +0 / -0,025
D 8,0 - 9,0 +0 / -0,030
D 10,0 - 12,0 +0 / -0,035
Shank
Cylindrical h6, DIN6535 HA
Flute
35° and 38° right hand spiral,
center cutting
Field of application
All types of steel up to HRC55

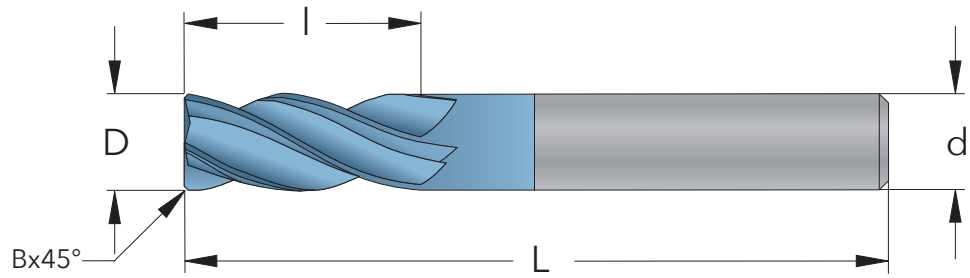

D mm	d mm	B mm	Part Number	l mm	L mm	No. of Flutes
6,0	6	0,2	MZ0606D16_LC	16	57	4
8,0	8	0,25	MZ0808D20_LC	20	63	4
10,0	10	0,3	MZ1010D25_LC	25	72	4
12,0	12	0,3	MZ1212D30_LC	30	83	4

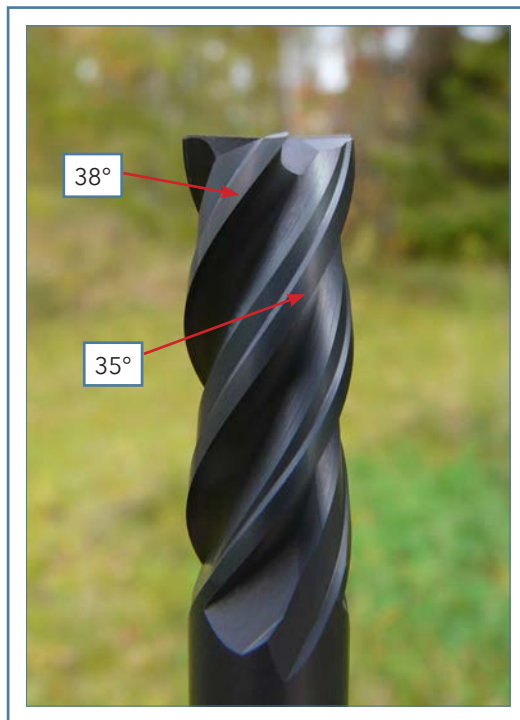

Less vibrations with
two different angles

Slot Side End Mill

LC

AlCrN coated

Super Micrograin Carbide

Tolerance

D 6,0 - 7,0 +0 / -0,025

D 8,0 - 9,0 +0 / -0,030

D 10,0 - 12,0 +0 / -0,035

Shank

Cylindrical h6, DIN6535 HA

Flute

50° right hand spiral, center cutting

Field of application

All types of steel up to HRC55

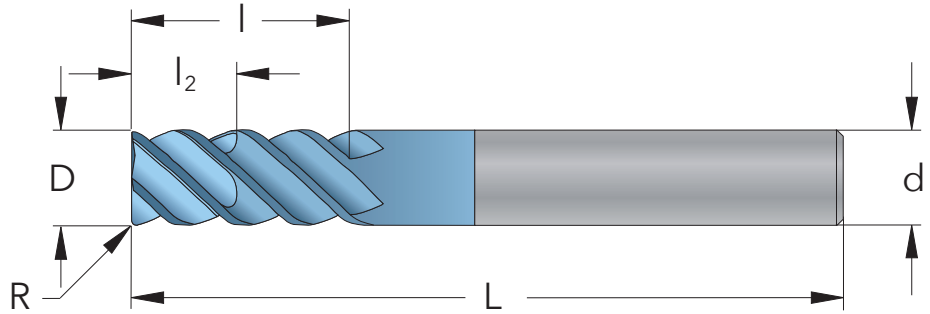

D mm	d mm	R mm	Part Number	l mm	l ₂ mm	L mm	No. of Flutes
6,0	6	0,4	MV0606D16_LC	16	6	57	4
8,0	8	0,5	MV0808D20_LC	20	8	63	4
10,0	10	0,6	MV1010D25_LC	25	10	72	4
12,0	12	0,6	MV1212D30_LC	30	12	83	4



Deep flute for slot milling

Shallow flute results in stronger tools for side milling

Wave formed, Roughing, Three Flute

LC
AlCrN coated
Super Micrograin Carbide
Tolerance
D 6,0 - 7,0 +0 / -0,025
D 8,0 - 9,0 +0 / -0,030
D 10,0 - 12,0 +0 / -0,035
Shank
Cylindrical h6, DIN6535 HA
Flute
35° right hand spiral, center cutting
Field of application
All types of steel up to HRC55

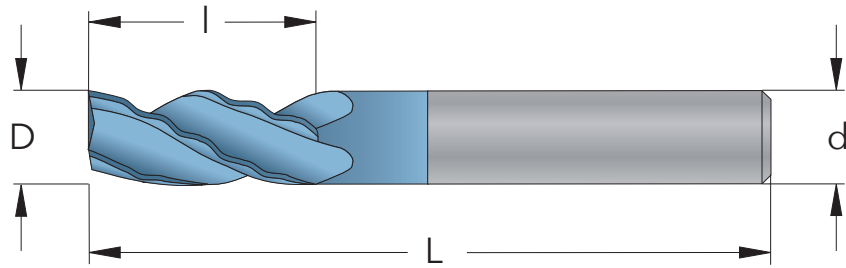

D mm	d mm	Part Number	l mm	L mm	No. of Flutes
6,0	6	FW0606C16_LC	16	57	3
8,0	8	FW0808C20_LC	20	63	3
10,0	10	FW1010C25_LC	25	72	3
12,0	12	FW1212C30_LC	30	83	3



Wave formed, Roughing, Four Flute

LC

AlCrN coated

Super Micrograin Carbide

Tolerance

D 6,0 - 7,0 +0 / -0,025

D 8,0 - 9,0 +0 / -0,030

D 10,0 - 12,0 +0 / -0,035

Shank

Cylindrical h6, DIN6535 HA

Flute

35° right hand spiral, center cutting

Field of application

All types of steel up to HRC55

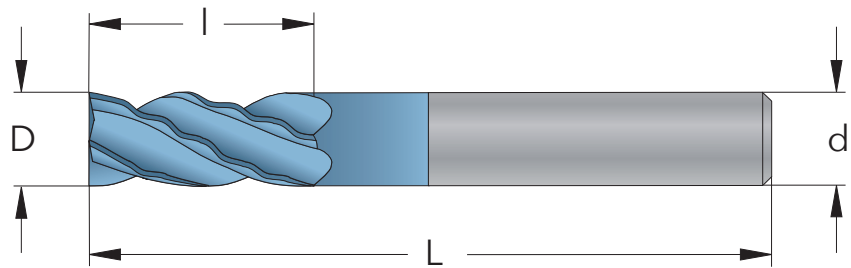

D mm	d mm	Part Number	l mm	L mm	No. of Flutes
6,0	6	FW0606D16_LC	16	57	4
8,0	8	FW0808D20_LC	20	63	4
10,0	10	FW1010D25_LC	25	72	4
12,0	12	FW1212D30_LC	30	83	4



Wave formed cutting edge
gives high productivity

Two Flute, for aluminium

MG

Uncoated
Super Micrograin Carbide

Tolerance

D 1,0 - 5,0 +0 / -0,020
D 6,0 - 7,0 +0 / -0,025
D 8,0 - 9,0 +0 / -0,030
D 10,0 - 12,0 +0 / -0,035

Shank

Cylindrical h6, DIN6535 HA

Flute

45° right hand spiral, center cutting

Field of application

Aluminium

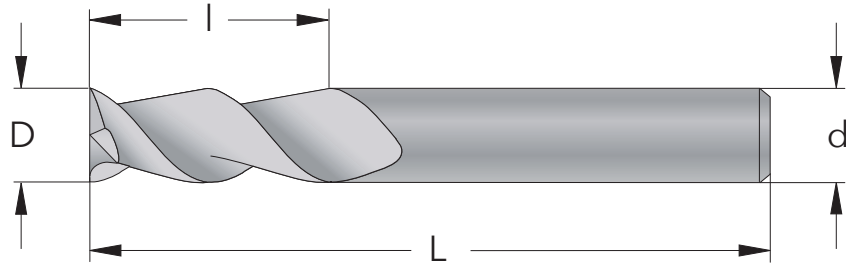

D mm	d mm	Part Number	l mm	L mm	No. of Flutes
2,0	6	MA0602B6_MG	6	57	2
3,0	6	MA0603B8_MG	8	57	2
4,0	6	MA0604B11_MG	11	57	2
5,0	6	MA0605B13_MG	13	57	2
6,0	6	MA0606B16_MG	16	57	2
8,0	8	MA0808B20_MG	20	63	2
10,0	10	MA1010B25_MG	25	72	2
12,0	12	MA1212B30_MG	30	83	2



Three Flute, for aluminium

MG

Uncoated

Super Micrograin Carbide

Tolerance

D 1,0 - 5,0 +0 / -0,020

D 6,0 - 7,0 +0 / -0,025

D 8,0 - 9,0 +0 / -0,030

D 10,0 - 12,0 +0 / -0,035

Shank

Cylindrical h6, DIN6535 HA

Flute

50° right hand spiral, center cutting

Field of application

Aluminium

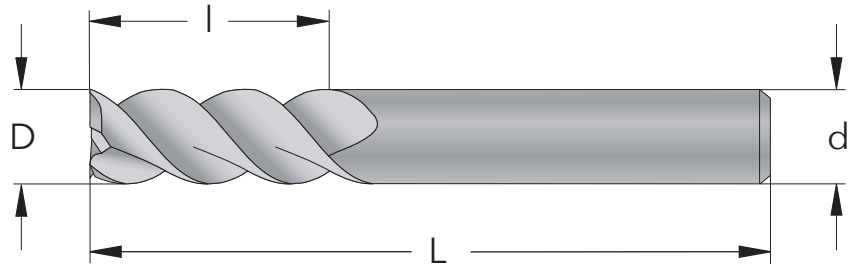

D mm	d mm	Part Number	l mm	L mm	No. of Flutes
2,0	6	MA0602C6_MG	6	57	3
3,0	6	MA0603C8_MG	8	57	3
4,0	6	MA0604C11_MG	11	57	3
5,0	6	MA0605C13_MG	13	57	3
6,0	6	MA0606C16_MG	16	57	3
8,0	8	MA0808C20_MG	20	63	3
10,0	10	MA1010C25_MG	25	72	3
12,0	12	MA1212C30_MG	30	83	3



Wave formed, Roughing, for aluminium

MG
 Uncoated
 Super Micrograin Carbide
Tolerance
 D 6,0 - 7,0 +0 / -0,025
 D 8,0 - 9,0 +0 / -0,030
 D 10,0 - 12,0 +0 / -0,035
Shank
 Cylindrical h6, DIN6535 HA
Flute
 45° right hand spiral, center cutting
Field of application
 Aluminium

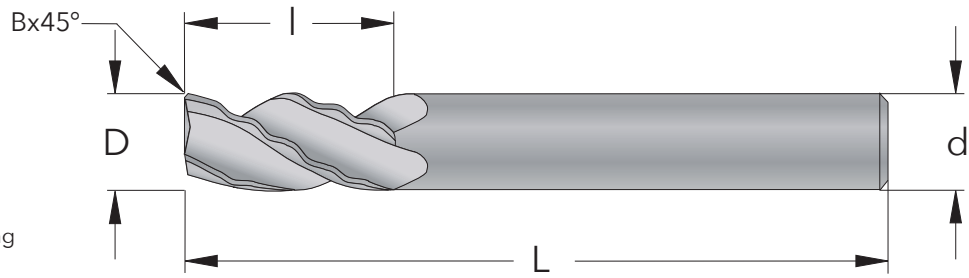

D mm	d mm	B mm	Part Number	l mm	L mm	No. of Flutes
6,0	6	0,2	FWA0606C16_MG	16	57	3
8,0	8	0,25	FWA0808C20_MG	20	63	3
10,0	10	0,3	FWA1010C25_MG	25	72	3
12,0	12	0,3	FWA1212C30_MG	30	83	3

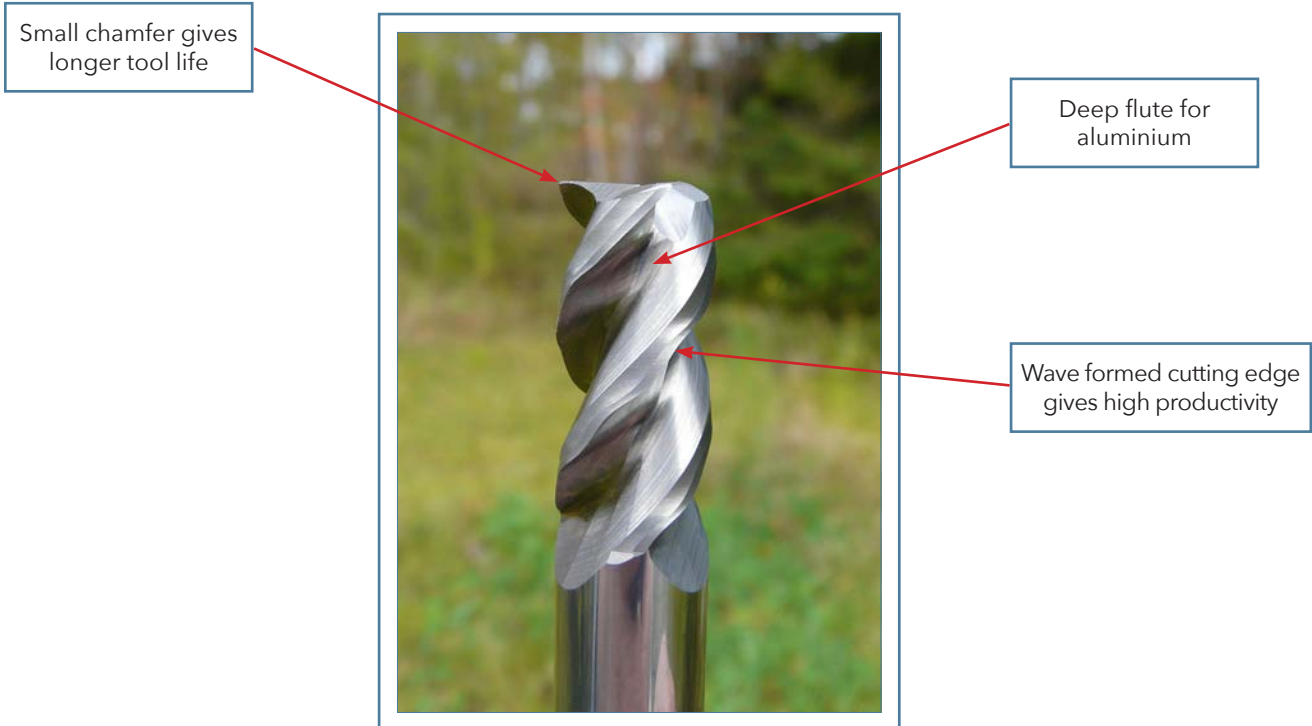

Two Flute

FC

TiAlN coated

Micrograin Carbide

Tolerance

D 1,0 - 25,0 +0 / -0,050

Shank

Cylindrical med h6 Tolerance

Flute

30° right hand spiral, center cutting

Field of application

All types of steel

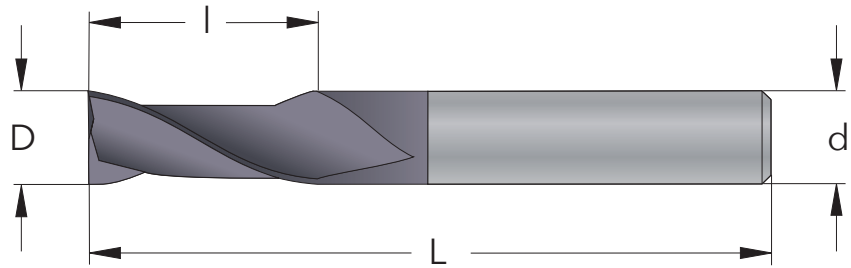

D mm	d mm	Part Number	l mm	L mm	No. of Flutes
1,0	3	M0301B3_FC	3	38	2
1,5	3	M03015B5_FC	5	38	2
2,0	3	M0302B6_FC	6	38	2
2,5	3	M03025B7_FC	7	38	2
3,0	3	M0303B12_FC	12	38	2
3,0	3	M0303B25_FC	25	65	2
3,5	4	M04035B12_FC	12	50	2
4,0	4	M0404B14_FC	14	50	2
4,0	4	M0404B25_FC	25	65	2
4,5	5	M05045B14_FC	14	50	2
5,0	5	M0505B16_FC	16	50	2
5,0	5	M0505B25_FC	25	75	2
6,0	6	M0606B19_FC	19	63	2
6,0	6	M0606B25_FC	25	75	2
6,0	6	M0606B38_FC	38	100	2
7,0	8	M0807B19_FC	19	63	2
8,0	8	M0808B19_FC	19	63	2
8,0	8	M0808B25_FC	25	75	2
8,0	8	M0808B38_FC	38	100	2
9,0	10	M1009B22_FC	22	70	2
10,0	10	M1010B22_FC	22	70	2
10,0	10	M1010B38_FC	38	100	2
12,0	12	M1212B25_FC	25	75	2
12,0	12	M1212B50_FC	50	100	2
12,0	12	M1212B75_FC	75	150	2
14,0	14	M1414B30_FC	30	88	2
14,0	14	M1414B75_FC	75	150	2
16,0	16	M1616B32_FC	32	88	2
16,0	16	M1616B75_FC	75	150	2
18,0	18	M1818B36_FC	36	100	2
20,0	20	M2020B38_FC	38	100	2
20,0	20	M2020B75_FC	75	150	2
25,0	25	M2525B38_FC	38	100	2
25,0	25	M2525B75_FC	75	150	2

Three Flute

FC
 TiAlN coated
 Micrograin Carbide
Tolerance
 D 1,0 - 25,0 +0 / -0,050
Shank
 Cylindrical med h6 Tolerance
Flute
 30° right hand spiral, center cutting
Field of application
 All types of steel

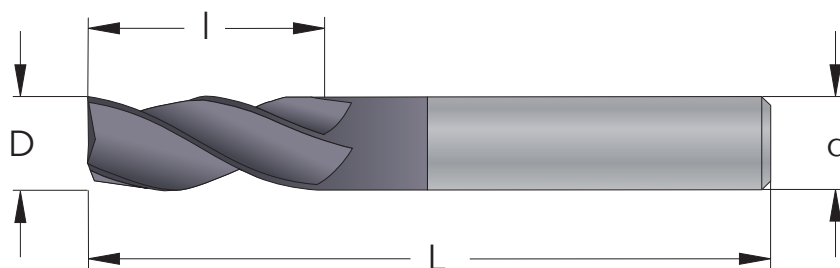

D mm	d mm	Part Number	l mm	L mm	No. of Flutes
1,0	3	M0301C3_FC	3	38	3
1,5	3	M03015C5_FC	5	38	3
2,0	3	M0302C6_FC	6	38	3
2,5	3	M03025C7_FC	7	38	3
3,0	3	M0303C12_FC	12	38	3
3,0	3	M0303C25_FC	25	65	3
3,5	4	M04035C12_FC	12	50	3
4,0	4	M0404C14_FC	14	50	3
4,0	4	M0404C25_FC	25	65	3
4,5	5	M05045C14_FC	14	50	3
5,0	5	M0505C16_FC	16	50	3
5,0	5	M0505C25_FC	25	75	3
6,0	6	M0606C19_FC	19	63	3
6,0	6	M0606C25_FC	25	75	3
7,0	8	M0807C19_FC	19	63	3
8,0	8	M0808C19_FC	19	63	3
8,0	8	M0808C25_FC	25	75	3
9,0	10	M1009C22_FC	22	70	3
10,0	10	M1010C22_FC	22	70	3
10,0	10	M1010C38_FC	38	100	3
12,0	12	M1212C25_FC	25	75	3
12,0	12	M1212C50_FC	50	100	3
14,0	14	M1414C30_FC	30	88	3
16,0	16	M1616C32_FC	32	88	3
16,0	16	M1616C75_FC	75	150	3
18,0	18	M1818C36_FC	36	100	3
20,0	20	M2020C38_FC	38	100	3
20,0	20	M2020C75_FC	75	150	3
25,0	25	M2525C38_FC	38	100	3
25,0	25	M2525C75_FC	75	150	3

Four Flute

FC

TiAlN coated

Micrograin Carbide

Tolerance

D 1,0 - 25,0 +0 / -0,050

Shank

Cylindrical med h6 Tolerance

Flute

30° right hand spiral, center cutting

Field of application

All types of steel

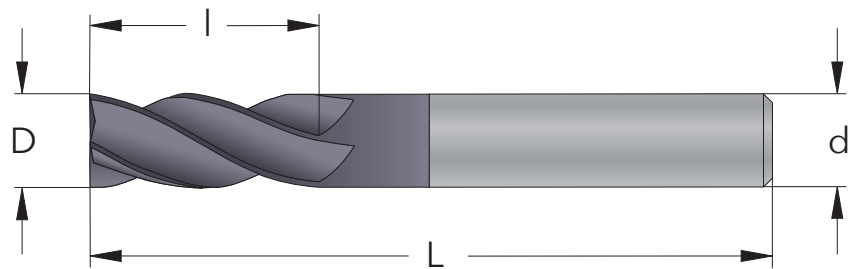

D mm	d mm	Part Number	l mm	L mm	No. of Flutes
1,0	3	M0301D3_FC	3	38	4
1,5	3	M03015D5_FC	5	38	4
2,0	3	M0302D6_FC	6	38	4
2,5	3	M03025D7_FC	7	38	4
3,0	3	M0303D12_FC	12	38	4
3,0	3	M0303D25_FC	25	65	4
3,5	4	M04035D12_FC	12	50	4
4,0	4	M0404D14_FC	14	50	4
4,0	4	M0404D25_FC	25	65	4
4,5	5	M05045D14_FC	14	50	4
5,0	5	M0505D16_FC	16	50	4
5,0	5	M0505D25_FC	25	75	4
6,0	6	M0606D19_FC	19	63	4
6,0	6	M0606D25_FC	25	75	4
6,0	6	M0606D38_FC	38	100	4
7,0	8	M0807D19_FC	19	63	4
8,0	8	M0808D19_FC	19	63	4
8,0	8	M0808D25_FC	25	75	4
8,0	8	M0808D38_FC	38	100	4
9,0	10	M1009D22_FC	22	70	4
10,0	10	M1010D22_FC	22	70	4
10,0	10	M1010D38_FC	38	100	4
12,0	12	M1212D25_FC	25	75	4
12,0	12	M1212D50_FC	50	100	4
12,0	12	M1212D75_FC	75	150	4
14,0	14	M1414D30_FC	30	88	4
14,0	14	M1414D75_FC	75	150	4
16,0	16	M1616D32_FC	32	88	4
16,0	16	M1616D75_FC	75	150	4
18,0	18	M1818D36_FC	36	100	4
20,0	20	M2020D38_FC	38	100	4
20,0	20	M2020D75_FC	75	150	4
25,0	25	M2525D38_FC	38	100	4
25,0	25	M2525D75_FC	75	150	4

Two Flute, with Corner Radius

FC
TiAlN coated
Micrograin Carbide
Tolerance
D 4,0 - 20,0 +0 / -0,050
Shank
Cylindrical med h6 Tolerance
Flute
30° right hand spiral, center cutting
Field of application
All types of steel

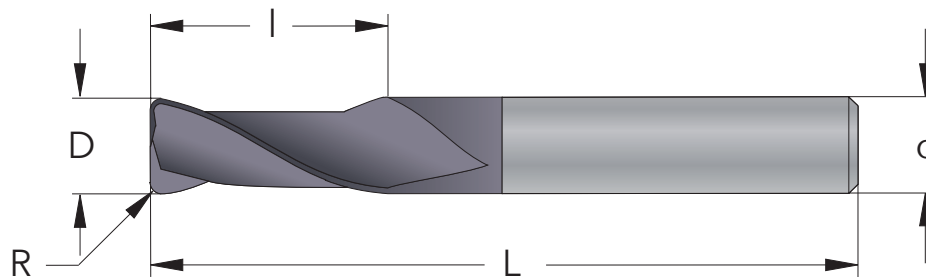

D mm	d mm	R mm	Part Number	l mm	L mm	No. of Flutes
4,0	4	0,25	M0404B14R025_FC	14	50	2
4,0	4	0,50	M0404B14R05_FC	14	50	2
4,0	4	0,75	M0404B14R075_FC	14	50	2
4,0	4	1,00	M0404B14R10_FC	14	50	2
6,0	6	0,25	M0606B19R025_FC	19	63	2
6,0	6	0,50	M0606B19R05_FC	19	63	2
6,0	6	0,75	M0606B19R075_FC	19	63	2
6,0	6	1,00	M0606B19R10_FC	19	63	2
6,0	6	1,25	M0606B19R125_FC	19	63	2
6,0	6	1,50	M0606B19R15_FC	19	63	2
8,0	8	0,50	M0808B19R05_FC	19	63	2
8,0	8	0,75	M0808B19R075_FC	19	63	2
8,0	8	1,00	M0808B19R10_FC	19	63	2
8,0	8	1,25	M0808B19R125_FC	19	63	2
8,0	8	1,50	M0808B19R15_FC	19	63	2
8,0	8	2,00	M0808B19R20_FC	19	63	2
10,0	10	0,50	M1010B22R05_FC	22	70	2
10,0	10	0,75	M1010B22R075_FC	22	70	2
10,0	10	1,00	M1010B22R10_FC	22	70	2
10,0	10	1,50	M1010B22R15_FC	22	70	2
10,0	10	2,00	M1010B22R20_FC	22	70	2
10,0	10	3,00	M1010B22R30_FC	22	70	2
12,0	12	0,50	M1212B25R05_FC	25	75	2
12,0	12	0,75	M1212B25R075_FC	25	75	2
12,0	12	1,00	M1212B25R10_FC	25	75	2
12,0	12	1,50	M1212B25R15_FC	25	75	2
12,0	12	2,00	M1212B25R20_FC	25	75	2
12,0	12	3,00	M1212B25R30_FC	25	75	2
16,0	16	0,50	M1616B32R05_FC	32	88	2
16,0	16	0,75	M1616B32R075_FC	32	88	2
16,0	16	1,00	M1616B32R10_FC	32	88	2
16,0	16	1,50	M1616B32R15_FC	32	88	2
16,0	16	2,00	M1616B32R20_FC	32	88	2
16,0	16	3,00	M1616B32R30_FC	32	88	2
20,0	20	0,50	M2020B38R05_FC	38	100	2
20,0	20	0,75	M2020B38R075_FC	38	100	2
20,0	20	1,00	M2020B38R10_FC	38	100	2
20,0	20	1,50	M2020B38R15_FC	38	100	2
20,0	20	2,00	M2020B38R20_FC	38	100	2
20,0	20	3,00	M2020B38R30_FC	38	100	2

Four Flute, with Corner Radius

FC

TiAlN coated

Micrograin Carbide

Tolerance

D 4,0 - 20,0 +0 / -0,050

Shank

Cylindrical med h6 Tolerance

Flute

30° right hand spiral, center cutting

Field of application

All types of steel

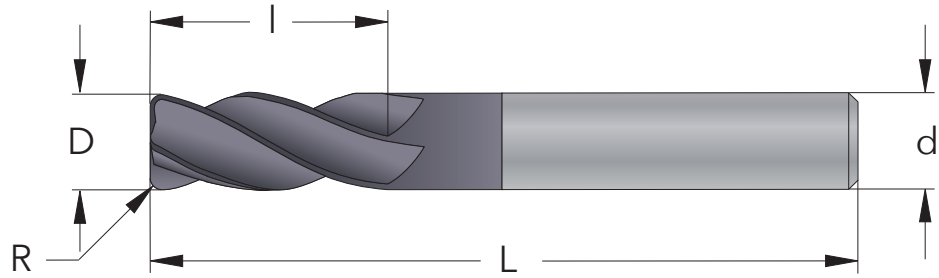

D mm	d mm	R mm	Part Number	l mm	L mm	No. of Flutes
4,0	4	0,25	M0404D14R025_FC	14	50	4
4,0	4	0,50	M0404D14R05_FC	14	50	4
4,0	4	0,75	M0404D14R075_FC	14	50	4
4,0	4	1,00	M0404D14R10_FC	14	50	4
6,0	6	0,25	M0606D19R025_FC	19	63	4
6,0	6	0,50	M0606D19R05_FC	19	63	4
6,0	6	0,75	M0606D19R075_FC	19	63	4
6,0	6	1,00	M0606D19R10_FC	19	63	4
6,0	6	1,25	M0606D19R125_FC	19	63	4
6,0	6	1,50	M0606D19R15_FC	19	63	4
8,0	8	0,50	M0808D19R05_FC	19	63	4
8,0	8	0,75	M0808D19R075_FC	19	63	4
8,0	8	1,00	M0808D19R10_FC	19	63	4
8,0	8	1,25	M0808D19R125_FC	19	63	4
8,0	8	1,50	M0808D19R15_FC	19	63	4
8,0	8	2,00	M0808D19R20_FC	19	63	4
10,0	10	0,50	M1010D22R05_FC	22	70	4
10,0	10	0,75	M1010D22R075_FC	22	70	4
10,0	10	1,00	M1010D22R10_FC	22	70	4
10,0	10	1,50	M1010D22R15_FC	22	70	4
10,0	10	2,00	M1010D22R20_FC	22	70	4
10,0	10	3,00	M1010D22R30_FC	22	70	4
12,0	12	0,50	M1212D25R05_FC	25	75	4
12,0	12	0,75	M1212D25R075_FC	25	75	4
12,0	12	1,00	M1212D25R10_FC	25	75	4
12,0	12	1,50	M1212D25R15_FC	25	75	4
12,0	12	2,00	M1212D25R20_FC	25	75	4
12,0	12	3,00	M1212D25R30_FC	25	75	4
16,0	16	0,50	M1616D32R05_FC	32	88	4
16,0	16	0,75	M1616D32R075_FC	32	88	4
16,0	16	1,00	M1616D32R10_FC	32	88	4
16,0	16	1,50	M1616D32R15_FC	32	88	4
16,0	16	2,00	M1616D32R20_FC	32	88	4
16,0	16	3,00	M1616D32R30_FC	32	88	4
20,0	20	0,50	M2020D38R05_FC	38	100	4
20,0	20	0,75	M2020D38R075_FC	38	100	4
20,0	20	1,00	M2020D38R10_FC	38	100	4
20,0	20	1,50	M2020D38R15_FC	38	100	4
20,0	20	2,00	M2020D38R20_FC	38	100	4
20,0	20	3,00	M2020D38R30_FC	38	100	4

Two Flute, with Ball Nose

FC
TiAlN coated
Micrograin Carbide
Tolerance
D 1,0 - 25,0 +0 / -0,050
Shank
Cylindrical med h6 Tolerance
Flute
30° right hand spiral
Field of application
All types of steel

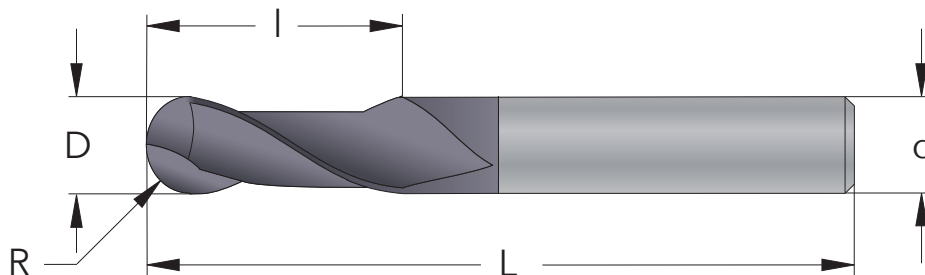

D mm	d mm	R mm	Part Number	l mm	L mm	No. of Flutes
1,0	3	0,50	R0301B3_FC	3	38	2
1,5	3	0,75	R03015B5_FC	5	38	2
2,0	3	1,00	R0302B6_FC	6	38	2
2,5	3	1,25	R03025B7_FC	7	38	2
3,0	3	1,50	R0303B12_FC	12	38	2
3,0	3	1,50	R0303B25_FC	25	65	2
4,0	4	2,00	R0404B14_FC	14	50	2
4,0	4	2,00	R0404B25_FC	25	65	2
5,0	5	2,50	R0505B16_FC	16	50	2
5,0	5	2,50	R0505B25_FC	25	75	2
6,0	6	3,00	R0606B19_FC	19	63	2
6,0	6	3,00	R0606B25_FC	25	75	2
6,0	6	3,00	R0606B38_FC	38	100	2
8,0	8	4,00	R0808B19_FC	19	63	2
8,0	8	4,00	R0808B25_FC	25	75	2
8,0	8	4,00	R0808B38_FC	38	100	2
10,0	10	5,00	R1010B22_FC	22	70	2
10,0	10	5,00	R1010B38_FC	38	100	2
12,0	12	6,00	R1212B25_FC	25	75	2
12,0	12	6,00	R1212B50_FC	50	100	2
12,0	12	6,00	R1212B75_FC	75	150	2
14,0	14	7,00	R1414B30_FC	30	88	2
16,0	16	8,00	R1616B32_FC	32	88	2
16,0	16	8,00	R1616B75_FC	75	150	2
18,0	18	9,00	R1818B36_FC	36	100	2
20,0	20	10,0	R2020B38_FC	38	100	2
20,0	20	10,0	R2020B75_FC	75	150	2
25,0	25	12,5	R2525B75_FC	75	150	2

with Long Shank

D mm	d mm	R mm	Part Number	l mm	L mm	No. of Flutes
2,0	2	1,0	R0202B10L100_FC	10	100	2
3,0	3	1,5	R0303B12L100_FC	12	100	2
4,0	4	2,0	R0404B15L120_FC	15	120	2
5,0	5	2,5	R0505B15L150_FC	15	150	2
6,0	6	3,0	R0606B20L150_FC	20	150	2
8,0	8	4,0	R0808B20L180_FC	20	180	2
10,0	10	5,0	R1010B25L200_FC	25	200	2
12,0	12	6,0	R1212B30L200_FC	30	200	2

Four Flute, with Ball Nose

FC
 TiAlN coated
 Micrograin Carbide
Tolerance
 D 1,0 - 25,0 +0 / -0,050
Shank
 Cylindrical med h6 Tolerance
Flute
 30° right hand spiral
Field of application
 All types of steel

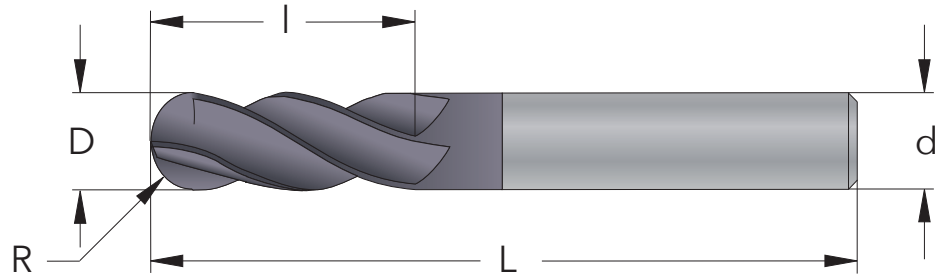

D mm	d mm	R mm	Part Number	l mm	L mm	No. of Flutes
1,0	3	0,50	R0301D3_FC	3	38	4
1,5	3	0,75	R03015D5_FC	5	38	4
2,0	3	1,00	R0302D6_FC	6	38	4
2,5	3	1,25	R03025D7_FC	7	38	4
3,0	3	1,50	R0303D12_FC	12	38	4
3,0	3	1,50	R0303D25_FC	25	65	4
4,0	4	2,00	R0404D14_FC	14	50	4
4,0	4	2,00	R0404D25_FC	25	65	4
5,0	5	2,50	R0505D16_FC	16	50	4
5,0	5	2,50	R0505D25_FC	25	75	4
6,0	6	3,00	R0606D19_FC	19	63	4
6,0	6	3,00	R0606D25_FC	25	75	4
6,0	6	3,00	R0606D38_FC	38	100	4
8,0	8	4,00	R0808D19_FC	19	63	4
8,0	8	4,00	R0808D25_FC	25	75	4
8,0	8	4,00	R0808D38_FC	38	100	4
10,0	10	5,00	R1010D22_FC	22	70	4
10,0	10	5,00	R1010D38_FC	38	100	4
12,0	12	6,00	R1212D25_FC	25	75	4
12,0	12	6,00	R1212D50_FC	50	100	4
12,0	12	6,00	R1212D75_FC	75	150	4
14,0	14	7,00	R1414D30_FC	30	88	4
16,0	16	8,00	R1616D32_FC	32	88	4
16,0	16	8,00	R1616D75_FC	75	150	4
18,0	18	9,00	R1818D36_FC	36	100	4
20,0	20	10,0	R2020D38_FC	38	100	4
20,0	20	10,0	R2020D75_FC	75	150	4
25,0	25	12,5	R2525D75_FC	75	150	4

High Helix

FC
TiAlN coated
Micrograin Carbide
Tolerance
D 10,0 - 32,0 +0 / -0,050
Shank
Cylindrical h6, DIN6535 HA
Flute
50° right hand spiral
Field of application
All types of steel

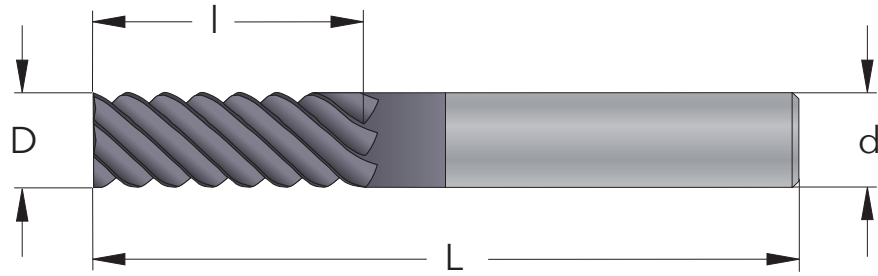

D mm	d mm	Part Number	l mm	L mm	No. of Flutes
10,0	10	U1010F25_FC	25	76	6
12,0	12	U1212F30_FC	30	83	6
16,0	16	U1616F40_FC	40	100	6
20,0	20	U2020F45_FC	45	120	6
25,0	25	U2525F60_FC	60	130	6

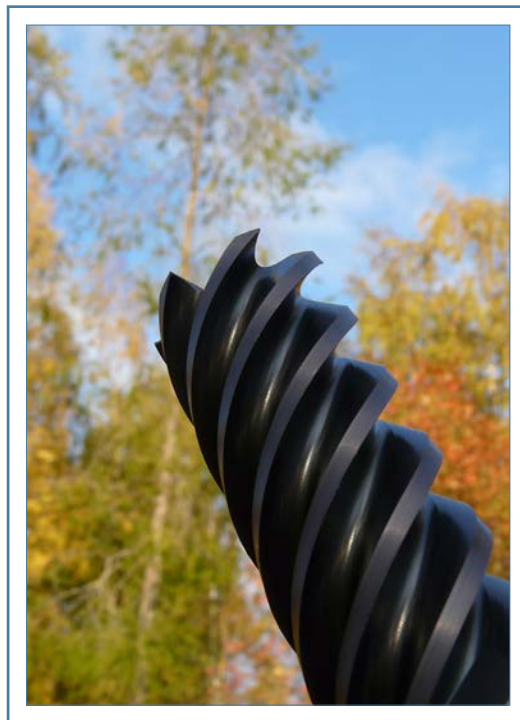

High Helix, for Hard Materials

FC

TiAlN coated

Micrograin Carbide

Tolerance

D 6,0 - 32,0 +0 / -0,050

Shank

Cylindrical h6, DIN6535 HA

Flute

50° right hand spiral

Negative cutting angle

Field of application

Hard materials up to HRC 65

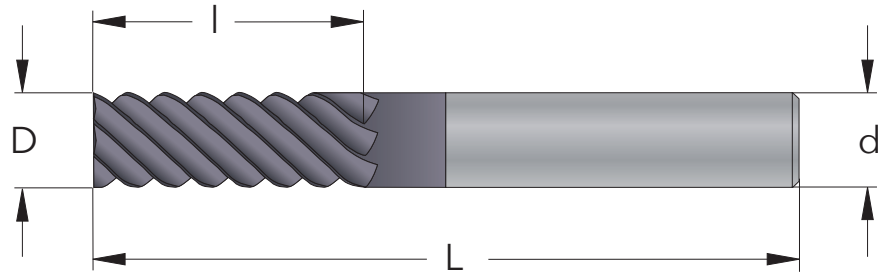

D mm	d mm	Part Number	l mm	L mm	No. of Flutes
6,0	6	V0606F15_FC	15	63	6
8,0	8	V0808F20_FC	20	76	6
10,0	10	V1010F25_FC	25	76	6
12,0	12	V1212F30_FC	30	83	6
16,0	16	V1616F40_FC	40	100	6
20,0	20	V2020F45_FC	45	120	6
25,0	25	V2525H60_FC	60	130	8



Micro, Two Flute

FC
TiAlN coated
Super Micrograin Carbide
Tolerance
D 0,3 - 3,0 -0,002 / -0,012
Shank
Cylindrical h5, DIN6535 HA
Flute
30° right hand spiral, center cutting
Field of application
High speed cutting in steel

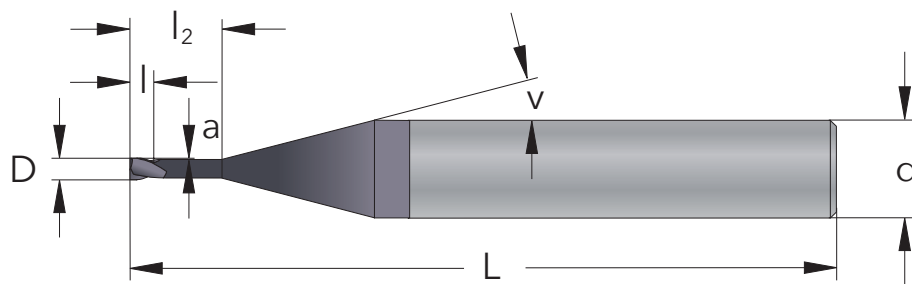

D mm	d mm	Part Number	l mm	l ₂ mm	L mm	a mm	v °	No. of Flutes
0,1	6	MP06001B0.2_FC	0,15	0,15	64		10	2
0,2	6	MP06002B0.3_FC	0,3	0,3	64		10	2
0,3	6	MP06003B0.5_FC	0,5	0,5	64		11	2
0,3	6	MP06003B0.6_FC	0,5	1,5	64	0,010	11	2
0,3	6	MP06003B0.7_FC	0,5	3,0	64	0,010	12	2
0,4	6	MP06004B0.7_FC	0,6	0,6	64		11	2
0,4	6	MP06004B0.8_FC	0,6	2,0	64	0,010	11	2
0,4	6	MP06004B0.9_FC	0,6	4,0	64	0,010	13	2
0,5	6	MP06005B0.9_FC	0,8	0,8	64		11	2
0,5	6	MP06005B1_FC	0,8	3,0	64	0,015	12	2
0,5	6	MP06005B1.1_FC	0,8	6,0	64	0,015	15	2
0,5	6	MP06005B1.2_FC	0,8	8,0	64	0,015	15	2
0,5	6	MP06005B1.3_FC	0,8	10,0	64	0,015	15	2
0,6	6	MP06006B1.1_FC	0,9	0,9	64		10	2
0,6	6	MP06006B1.15_FC	0,9	2,0	64	0,025	11	2
0,6	6	MP06006B1.2_FC	0,9	4,0	64	0,025	13	2
0,6	6	MP06006B1.3_FC	0,9	6,0	64	0,025	15	2
0,6	6	MP06006B1.4_FC	0,9	8,0	64	0,025	15	2
0,6	6	MP06006B1.5_FC	0,9	10,0	64	0,025	15	2
0,8	6	MP06008B1.5_FC	1,2	1,2	64		10	2
0,8	6	MP06008B1.55_FC	1,2	2,5	64	0,025	11	2
0,8	6	MP06008B1.6_FC	1,2	5,0	64	0,025	13	2
0,8	6	MP06008B1.7_FC	1,2	8,0	64	0,025	15	2
0,8	6	MP06008B1.8_FC	1,2	10,0	64	0,025	15	2
1,0	6	MP0601B1.9_FC	1,5	1,5	64		10	2
1,0	6	MP0601B1.95_FC	1,5	4,0	64	0,025	12	2
1,0	6	MP0601B2_FC	1,5	6,0	64	0,025	14	2
1,0	6	MP0601B2.1_FC	1,5	10,0	64	0,025	15	2
1,0	6	MP0601B2.2_FC	1,5	15,0	64	0,025	15	2
1,0	6	MP0601B2.3_FC	1,5	20,0	64	0,025	15	2
1,0	6	MP0601B2.4_FC	1,5	25,0	64	0,025	15	2
1,2	6	MP06012B2.3_FC	1,8	1,8	64		10	2
1,2	6	MP06012B2.34_FC	1,8	4,0	64	0,025	11	2
1,2	6	MP06012B2.37_FC	1,8	6,0	64	0,025	14	2
1,2	6	MP06012B2.4_FC	1,8	8,0	64	0,025	15	2
1,2	6	MP06012B2.5_FC	1,8	12,0	64	0,025	15	2
1,2	6	MP06012B2.6_FC	1,8	16,0	64	0,025	15	2
1,5	6	MP06015B2.9_FC	2,3	2,3	64		10	2
1,5	6	MP06015B2.95_FC	2,3	6,0	64	0,025	13	2
1,5	6	MP06015B3_FC	2,3	10,0	64	0,025	15	2
1,5	6	MP06015B3.1_FC	2,3	15,0	64	0,025	15	2
1,5	6	MP06015B3.2_FC	2,3	20,0	64	0,025	15	2
1,5	6	MP06015B3.3_FC	2,3	25,0	64	0,025	15	2
2,0	6	MP0602B2.9_FC	3,0	3,0	64		9	2
2,0	6	MP0602B2.95_FC	3,0	6,0	64	0,05	11	2

continue

Micro, Two Flute

D mm	d mm	Part Number	l mm	l ₂ mm	L mm	a mm	v °	No. of Flutes
2,0	6	MP0602B3_FC	3,0	10,0	64	0,05	15	2
2,0	6	MP0602B3.1_FC	3,0	16,0	64	0,05	15	2
2,0	6	MP0602B3.2_FC	3,0	20,0	64	0,05	15	2
2,0	6	MP0602B3.3_FC	3,0	25,0	64	0,05	15	2
2,0	6	MP0602B3.4_FC	3,0	30,0	64	0,05	15	2
2,5	6	MP06025B2.9_FC	3,0	3,0	64		8	2
2,5	6	MP06025B2.95_FC	3,0	6,0	64	0,05	10	2
2,5	6	MP06025B3_FC	3,0	10,0	64	0,05	15	2
2,5	6	MP06025B3.1_FC	3,0	16,0	64	0,05	15	2
2,5	6	MP06025B3.2_FC	3,0	20,0	64	0,05	15	2
2,5	6	MP06025B3.3_FC	3,0	25,0	64	0,05	15	2
3,0	6	MP0603B2.9_FC	3,0	3,0	64		7	2
3,0	6	MP0603B2.95_FC	3,0	6,0	64	0,05	9	2
3,0	6	MP0603B3_FC	3,0	10,0	64	0,05	14	2
3,0	6	MP0603B3.1_FC	3,0	16,0	64	0,05	15	2
3,0	6	MP0603B3.2_FC	3,0	20,0	64	0,05	15	2
3,0	6	MP0603B3.3_FC	3,0	25,0	64	0,05	15	2
3,0	6	MP0603B3.4_FC	3,0	30,0	64	0,05	15	2

■ Micro End Mills are available with Corner Radius. The price is 10% higher.



Micro, Two Flute, with Ball Nose

FC
TiAlN coated
Super Micrograin Carbide
Tolerance
D 0,3 - 3,0 -0,002 / -0,012
Shank
Cylindrical h5, DIN6535 HA
Flute
30° right hand spiral
Field of application
High speed cutting in steel

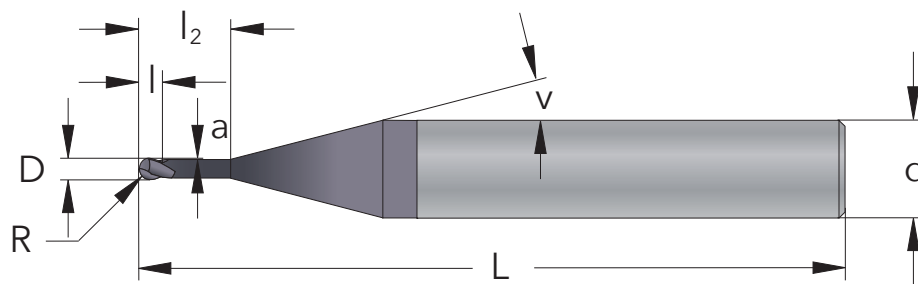

D mm	d mm	R mm	Part Number	l mm	l ₂ mm	L mm	a mm	v °	No. of Flutes
0,2	6	0,10	RP06002B0.3_FC	0,3	0,3	64		10	2
0,3	6	0,15	RP06003B0.5_FC	0,5	0,5	64		11	2
0,3	6	0,15	RP06003B0.6_FC	0,5	1,5	64	0,010	11	2
0,3	6	0,15	RP06003B0.7_FC	0,5	3,0	64	0,010	12	2
0,4	6	0,2	RP06004B0.7_FC	0,6	0,6	64		11	2
0,4	6	0,2	RP06004B0.8_FC	0,6	2,0	64	0,010	11	2
0,4	6	0,2	RP06004B0.9_FC	0,6	4,0	64	0,010	13	2
0,5	6	0,25	RP06005B0.9_FC	0,8	0,8	64		11	2
0,5	6	0,25	RP06005B1_FC	0,8	3,0	64	0,015	12	2
0,5	6	0,25	RP06005B1.1_FC	0,8	6,0	64	0,015	15	2
0,5	6	0,25	RP06005B1.2_FC	0,8	8,0	64	0,015	15	2
0,5	6	0,25	RP06005B1.3_FC	0,8	10,0	64	0,015	15	2
0,6	6	0,3	RP06006B1.1_FC	0,9	0,9	64		10	2
0,6	6	0,3	RP06006B1.15_FC	0,9	2,0	64	0,025	11	2
0,6	6	0,3	RP06006B1.2_FC	0,9	4,0	64	0,025	13	2
0,6	6	0,3	RP06006B1.3_FC	0,9	6,0	64	0,025	15	2
0,6	6	0,3	RP06006B1.4_FC	0,9	8,0	64	0,025	15	2
0,6	6	0,3	RP06006B1.5_FC	0,9	10,0	64	0,025	15	2
0,8	6	0,4	RP06008B1.5_FC	1,2	1,2	64		10	2
0,8	6	0,4	RP06008B1.55_FC	1,2	2,5	64	0,025	11	2
0,8	6	0,4	RP06008B1.6_FC	1,2	5,0	64	0,025	13	2
0,8	6	0,4	RP06008B1.7_FC	1,2	8,0	64	0,025	15	2
0,8	6	0,4	RP06008B1.8_FC	1,2	10,0	64	0,025	15	2
1,0	6	0,5	RP0601B1.9_FC	1,5	1,5	64		10	2
1,0	6	0,5	RP0601B1.95_FC	1,5	4,0	64	0,025	12	2
1,0	6	0,5	RP0601B2_FC	1,5	6,0	64	0,025	14	2
1,0	6	0,5	RP0601B2.1_FC	1,5	10,0	64	0,025	15	2
1,0	6	0,5	RP0601B2.2_FC	1,5	15,0	64	0,025	15	2
1,0	6	0,5	RP0601B2.3_FC	1,5	20,0	64	0,025	15	2
1,0	6	0,5	RP0601B2.4_FC	1,5	25,0	64	0,025	15	2
1,2	6	0,6	RP06012B2.3_FC	1,8	1,8	64		10	2
1,2	6	0,6	RP06012B2.34_FC	1,8	4,0	64	0,025	11	2
1,2	6	0,6	RP06012B2.37_FC	1,8	6,0	64	0,025	14	2
1,2	6	0,6	RP06012B2.4_FC	1,8	8,0	64	0,025	15	2
1,2	6	0,6	RP06012B2.5_FC	1,8	12,0	64	0,025	15	2
1,2	6	0,6	RP06012B2.6_FC	1,8	16,0	64	0,025	15	2
1,5	6	0,75	RP06015B2.9_FC	2,3	2,3	64		10	2
1,5	6	0,75	RP06015B2.95_FC	2,3	6,0	64	0,025	13	2
1,5	6	0,75	RP06015B3_FC	2,3	10,0	64	0,025	15	2
1,5	6	0,75	RP06015B3.1_FC	2,3	15,0	64	0,025	15	2
1,5	6	0,75	RP06015B3.2_FC	2,3	20,0	64	0,025	15	2
1,5	6	0,75	RP06015B3.3_FC	2,3	25,0	64	0,025	15	2
2,0	6	1,0	RP0602B2.9_FC	3,0	3,0	64		9	2
2,0	6	1,0	RP0602B2.95_FC	3,0	6,0	64	0,05	11	2
2,0	6	1,0	RP0602B3_FC	3,0	10,0	64	0,05	15	2

D mm	d mm	R mm	Part Number	l mm	l ₂ mm	L mm	a mm	v °	No. of Flutes
2,0	6	1,0	RP0602B3.1_FC	3,0	16,0	64	0,05	15	2
2,0	6	1,0	RP0602B3.2_FC	3,0	20,0	64	0,05	15	2
2,0	6	1,0	RP0602B3.3_FC	3,0	25,0	64	0,05	15	2
2,0	6	1,0	RP0602B3.4_FC	3,0	30,0	64	0,05	15	2
2,5	6	1,25	RP06025B2.9_FC	3,0	3,0	64		8	2
2,5	6	1,25	RP06025B2.95_FC	3,0	6,0	64	0,05	10	2
2,5	6	1,25	RP06025B3_FC	3,0	10,0	64	0,05	15	2
2,5	6	1,25	RP06025B3.1_FC	3,0	16,0	64	0,05	15	2
2,5	6	1,25	RP06025B3.2_FC	3,0	20,0	64	0,05	15	2
2,5	6	1,25	RP06025B3.3_FC	3,0	25,0	64	0,05	15	2
3,0	6	1,5	RP0603B2.9_FC	3,0	3,0	64		7	2
3,0	6	1,5	RP0603B2.95_FC	3,0	6,0	64	0,05	9	2
3,0	6	1,5	RP0603B3_FC	3,0	10,0	64	0,05	14	2
3,0	6	1,5	RP0603B3.1_FC	3,0	16,0	64	0,05	15	2
3,0	6	1,5	RP0603B3.2_FC	3,0	20,0	64	0,05	15	2
3,0	6	1,5	RP0603B3.3_FC	3,0	25,0	64	0,05	15	2
3,0	6	1,5	RP0603B3.4_FC	3,0	30,0	64	0,05	15	2

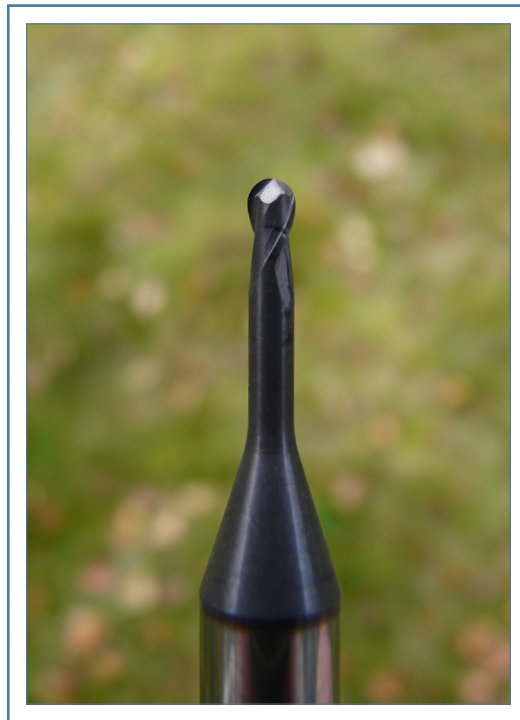

Two Flute, with Corner Radius

FC

TiAlN coated

Super Micrograin Carbide

Tolerance

D 1,0 - 3,0 -0,002 / -0,012

D 4,0 - 6,0 -0,004 / -0,016

D 7,0 - 10,0 -0,005 / -0,020

D 11,0 - 18,0 -0,006 / -0,024

Shank

Cylindrical h5, DIN6535 HA

Flute

30° right hand spiral, center cutting

Field of application

High speed cutting in steel

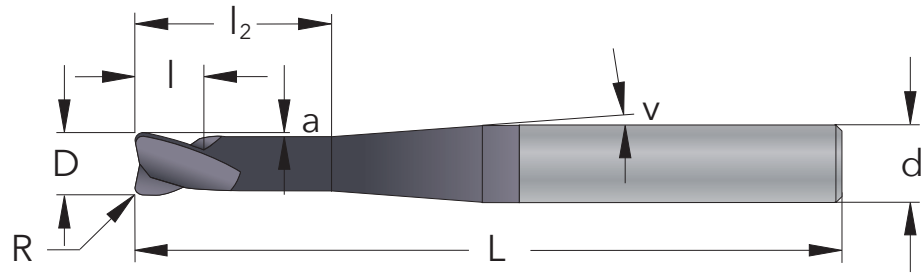

D mm	d mm	R mm	Part Number	l mm	l ₂ mm	L mm	a mm	v °	No. of Flutes
1,5	6	0,3	MH06015B2R03L64_FC	2	5	64	0,05	7,0	2
1,5	6	0,3	MH06015B2.1R03L64_FC	2	10	64	0,05	9,0	2
2,0	6	0,5	MH0602B3R05L64_FC	3	5	64	0,05	6,0	2
2,0	6	0,5	MH0602B3.1R05L64_FC	3	10	64	0,05	8,0	2
2,0	6	0,5	MH0602B3R05L78_FC	3	15	78	0,05	5,0	2
3,0	6	0,5	MH0603B4R05L64_FC	4	7	64	0,05	5,0	2
3,0	6	0,5	MH0603B4R05L78_FC	4	15	78	0,05	4,0	2
4,0	6	0,5	MH0604B5R05L64_FC	5	8	64	0,1	4,0	2
4,0	6	0,5	MH0604B5R05L78_FC	5	15	78	0,1	2,5	2
4,0	6	1,0	MH0604B5R10L64_FC	5	8	64	0,1	4,0	2
4,0	6	1,0	MH0604B5R10L78_FC	5	15	78	0,1	2,5	2
5,0	6	0,5	MH0605B5R05L64_FC	5	10	64	0,15	2,5	2
5,0	6	0,5	MH0605B5R05L78_FC	5	20	78	0,15	2,0	2
5,0	6	1,0	MH0605B5R10L64_FC	5	10	64	0,15	2,5	2
5,0	6	1,0	MH0605B5R10L78_FC	5	20	78	0,15	2,0	2
6,0	6	0,5	MH0606B6R05L64_FC	6	25	64	0,2		2
6,0	6	0,5	MH0606B6R05L78_FC	6	35	78	0,2		2
6,0	8	0,5	MH0806B6R05L100_FC	6	25	100	0,2	2,0	2
6,0	6	1,0	MH0606B6R10L64_FC	6	25	64	0,2		2
6,0	6	1,0	MH0606B6R10L78_FC	6	35	78	0,2		2
6,0	8	1,0	MH0806B6R10L100_FC	6	25	100	0,2		2
6,0	6	1,5	MH0606B6R15L64_FC	6	25	64	0,2		2
6,0	6	1,5	MH0606B6R15L78_FC	6	35	78	0,2		2
6,0	8	1,5	MH0806B6R15L100_FC	6	25	100	0,2	2,0	2
8,0	8	0,5	MH0808B8R05L64_FC	8	25	64	0,3		2
8,0	8	0,5	MH0808B8R05L78_FC	8	25	78	0,3		2
8,0	8	1,0	MH0808B8R10L64_FC	8	25	64	0,3		2
8,0	8	1,0	MH0808B8R10L78_FC	8	35	78	0,3		2
8,0	8	1,0	MH0808B8R10L100_FC	8	50	100	0,3		2
8,0	8	2,0	MH0808B8R20L64_FC	8	25	64	0,3		2
8,0	8	2,0	MH0808B8R20L78_FC	8	35	78	0,3		2
8,0	8	2,0	MH0808B8R20L100_FC	8	50	100	0,3		2
8,0	10	1,0	MH1008B8R10L120_FC	8	30	120	0,3	1,5	2
8,0	10	2,0	MH1008B8R20L120_FC	8	30	120	0,3	1,5	2
10,0	10	0,5	MH1010B10R05L78_FC	10	35	78	0,3		2
10,0	10	1,0	MH1010B10R10L100_FC	10	55	100	0,3		2
10,0	10	2,0	MH1010B10R20L78_FC	10	35	78	0,3		2
10,0	10	2,0	MH1010B10R20L100_FC	10	55	100	0,3		2
10,0	12	2,0	MH1210B10R20L120_FC	10	30	120	0,3	1,5	2
12,0	12	0,5	MH1212B12R05L78_FC	12	35	78	0,3		2
12,0	12	1,0	MH1212B12R10L100_FC	12	55	100	0,3		2
12,0	12	2,0	MH1212B12R20L78_FC	12	35	78	0,3		2
12,0	12	2,0	MH1212B12R20L100_FC	12	55	100	0,3		2
12,0	16	2,0	MH1612B12R20L120_FC	12	40	120	0,3	4,5	2
16,0	16	3,5	MH1616B20R35L100_FC	20	50	100	0,3		2
16,0	16	3,5	MH1616B20R35L150_FC	20	100	150	0,3		2

Four Flute, with Corner Radius

FC

TiAlN coated

Super Micrograin Carbide

Tolerance

D 1,0 - 3,0 -0,002 / -0,012

D 4,0 - 6,0 -0,004 / -0,016

D 7,0 - 10,0 -0,005 / -0,020

D 11,0 - 18,0 -0,006 / -0,024

Shank

Cylindrical h5, DIN6535 HA

Flute

30° right hand spiral, center cutting

Field of application

High speed cutting in steel

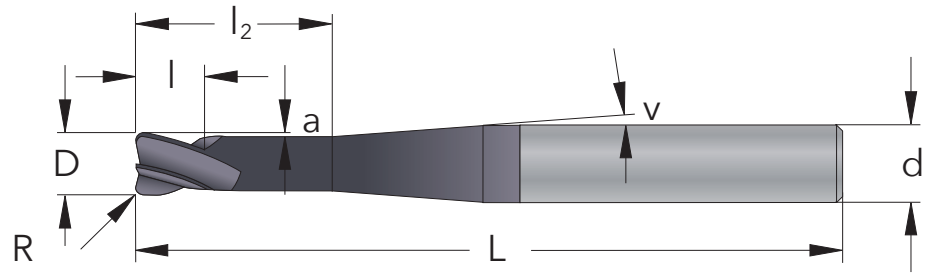

D mm	d mm	R mm	Part Number	l mm	l ₂ mm	L mm	a mm	v °	No. of Flutes
6,0	6	0,5	MH0606D6R05L64_FC	6	25	64	0,2		4
6,0	6	0,5	MH0606D6R05L78_FC	6	35	78	0,2		4
6,0	6	1,0	MH0606D6R10L64_FC	6	25	64	0,2		4
6,0	6	1,5	MH0606D6R15L64_FC	6	25	64	0,2		4
6,0	6	1,5	MH0606D6R15L78_FC	6	35	78	0,2		4
6,0	8	0,5	MH0806D6R05L100_FC	6	25	100	0,2	2,0	4
6,0	8	1,5	MH0806D6R15L100_FC	6	25	100	0,2	2,0	4
8,0	8	0,5	MH0808D8R05L64_FC	8	25	64	0,3		4
8,0	8	0,5	MH0808D8R05L78_FC	8	25	78	0,3		4
8,0	8	1,0	MH0808D8R10L64_FC	8	25	64	0,3		4
8,0	8	1,0	MH0808D8R10L78_FC	8	35	78	0,3		4
8,0	8	1,0	MH0808D8R10L100_FC	8	50	100	0,3		4
8,0	8	2,0	MH0808D8R20L64_FC	8	25	64	0,3		4
8,0	8	2,0	MH0808D8R20L78_FC	8	35	78	0,3		4
8,0	8	2,0	MH0808D8R20L100_FC	8	50	100	0,3		4
8,0	10	1,0	MH1008D8R10L120_FC	8	30	120	0,3	1,5	4
8,0	10	2,0	MH1008D8R20L120_FC	8	30	120	0,3	1,5	4
10,0	10	0,5	MH1010D10R05L78_FC	10	35	78	0,3		4
10,0	10	1,0	MH1010D10R10L100_FC	10	55	100	0,3		4
10,0	10	2,0	MH1010D10R20L78_FC	10	35	78	0,3		4
10,0	10	2,0	MH1010D10R20L100_FC	10	55	100	0,3		4
10,0	12	2,0	MH1210D10R20L120_FC	10	30	120	0,3	1,5	4
12,0	12	0,5	MH1212D12R05L78_FC	12	35	78	0,3		4
12,0	12	1,0	MH1212D12R10L100_FC	12	55	100	0,3		4
12,0	12	2,0	MH1212D12R20L78_FC	12	35	78	0,3		4
12,0	12	2,0	MH1212D12R20L100_FC	12	55	100	0,3		4
12,0	16	2,0	MH1612D12R20L120_FC	12	40	120	0,3	4,5	4
16,0	16	3,5	MH1616D20R35L100_FC	20	50	100	0,3		4
16,0	16	3,5	MH1616D20R35L150_FC	20	100	150	0,3		4

Two Flute, with Ball Nose

FC
 TiAlN coated
 Super Micrograin Carbide
Tolerance
 D 1,0 - 3,0 -0,002 / -0,012
 D 4,0 - 6,0 -0,004 / -0,016
 D 7,0 - 10,0 -0,005 / -0,020
 D 11,0 - 18,0 -0,006 / -0,024
Shank
 Cylindrical h5, DIN6535 HA
Flute
 30° right hand spiral
Field of application
 High speed cutting in steel

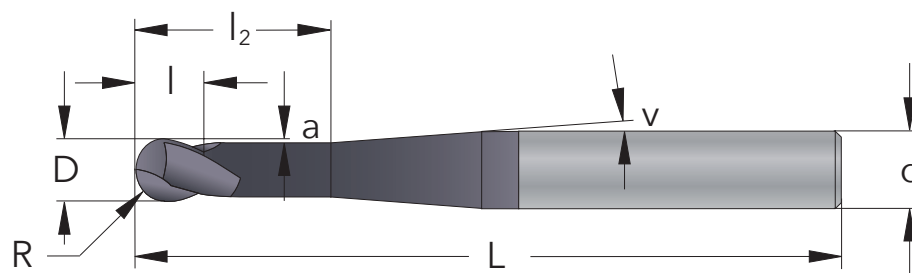

D mm	d mm	R mm	Part Number	l mm	l ₂ mm	L mm	a mm	v °	No. of Flutes
1,0	6	0,5	RH0601B2L64_FC	2	4	64	0,05	7,0	2
1,5	6	0,75	RH06015B2L64_FC	2	4	64	0,05	6,5	2
2,0	6	1,0	RH0602B3L64_FC	3	5	64	0,05	6,0	2
2,0	6	1,0	RH0602B3L78_FC	3	15	78	0,05	5,0	2
3,0	6	1,5	RH0603B4L64_FC	4	7	64	0,05	5,0	2
3,0	6	1,5	RH0603B4L78_FC	4	15	78	0,05	4,0	2
4,0	6	2,0	RH0604B5L64_FC	5	8	64	0,1	4,0	2
4,0	6	2,0	RH0604B5L78_FC	5	15	78	0,1	2,5	2
5,0	6	2,5	RH0605B5L64_FC	5	10	64	0,15	2,5	2
5,0	6	2,5	RH0605B5L78_FC	5	20	78	0,15	2,0	2
6,0	6	3,0	RH0606B6L64_FC	6	25	64	0,2		2
6,0	6	3,0	RH0606B6L78_FC	6	35	78	0,2		2
6,0	8	3,0	RH0806B6L100_FC	6	25	100	0,2	2,0	2
6,0	8	3,0	RH0806B6L150_FC	6	15	150	0,2	1,5	2
8,0	8	4,0	RH0808B8L64_FC	8	25	64	0,3		2
8,0	8	4,0	RH0808B8L78_FC	8	35	78	0,3		2
8,0	8	4,0	RH0808B8L100_FC	8	50	100	0,3		2
8,0	10	4,0	RH1008B8L120_FC	8	30	120	0,3	1,5	2
8,0	10	4,0	RH1008B8L150_FC	8	20	150	0,3	1,5	2
10,0	10	5,0	RH1010B10L78_FC	10	35	78	0,3		2
10,0	10	5,0	RH1010B10L100_FC	10	55	100	0,3		2
10,0	12	5,0	RH1210B10L100_FC	10	30	100	0,3	3,5	2
10,0	12	5,0	RH1210B10L120_FC	10	30	120	0,3	1,5	2
10,0	12	5,0	RH1210B10L150_FC	10	25	150	0,3	1,5	2
12,0	12	6,0	RH1212B12L78_FC	12	35	78	0,3		2
12,0	12	6,0	RH1212B12L100_FC	12	55	100	0,3		2
12,0	16	6,0	RH1612B12L120_FC	12	40	120	0,3	4,5	2
12,0	16	6,0	RH1612B12L150_FC	12	30	150	0,3	2,0	2
16,0	16	8,0	RH1616B20L100_FC	20	50	100	0,3		2
16,0	16	8,0	RH1616B20L150_FC	20	100	150	0,3		2

Four Flute, with Ball Nose

FC

TiAlN coated

Super Micrograin Carbide

Tolerance

D 1,0 - 3,0 -0,002 / -0,012

D 4,0 - 6,0 -0,004 / -0,016

D 7,0 - 10,0 -0,005 / -0,020

D 11,0 - 18,0 -0,006 / -0,024

Shank

Cylindrical h5, DIN6535 HA

Flute

30° right hand spiral

Field of application

High speed cutting in steel

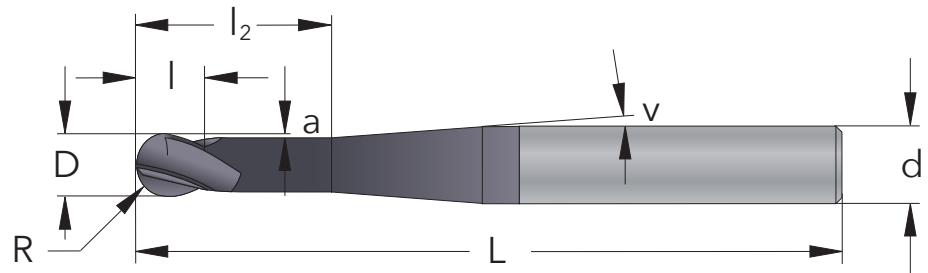

D mm	d mm	R mm	Part Number	l mm	l ₂ mm	L mm	a mm	v °	No. of Flutes
6,0	6	3,0	RH0606D6L64_FC	6	25	64	0,2		4
6,0	6	3,0	RH0606D6L78_FC	6	35	78	0,2		4
6,0	8	3,0	RH0806D6L100_FC	6	25	100	0,2	2,0	4
8,0	8	4,0	RH0808D8L64_FC	8	25	64	0,3		4
8,0	8	4,0	RH0808D8L78_FC	8	35	78	0,3		4
8,0	8	4,0	RH0808D8L100_FC	8	50	100	0,3		4
8,0	10	4,0	RH1008D8L120_FC	8	30	120	0,3	1,5	4
10,0	10	5,0	RH1010D10L78_FC	10	35	78	0,3		4
10,0	10	5,0	RH1010D10L100_FC	10	55	100	0,3		4
10,0	12	5,0	RH1210D10L120_FC	10	30	120	0,3	1,5	4
12,0	12	6,0	RH1212D12L78_FC	12	35	78	0,3		4
12,0	12	6,0	RH1212D12L100_FC	12	55	100	0,3		4
12,0	16	6,0	RH1612D12L120_FC	12	40	120	0,3	4,5	4
16,0	16	8,0	RH1616D20L100_FC	20	50	100	0,3		4
16,0	16	8,0	RH1616D20L150_FC	20	100	150	0,3		4

Roughing End Mill

FC
TiAlN coated
Super Micrograin Carbide
Tolerance
D 1,0 - 3,0 -0,002 / -0,012
D 4,0 - 6,0 -0,004 / -0,016
D 7,0 - 10,0 -0,005 / -0,020
D 11,0 - 18,0 -0,006 / -0,024
Shank
Cylindrical h5, DIN6535 HA
Flute
45° right hand spiral, center cutting
Field of application
High speed cutting in steel

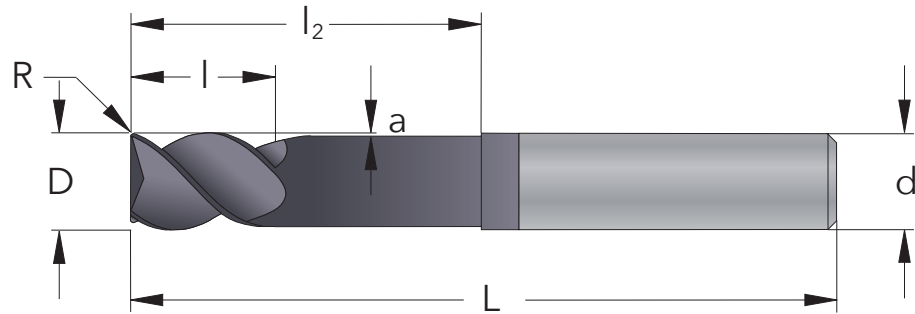

D mm	d mm	R mm	Part Number	l mm	l ₂ mm	L mm	a mm	No. of Flutes
3,0	3	0,2	TH0303C4_FC	4	10	39	0,05	3
4,0	6	0,2	TH0604C5_FC	5	12	64	0,1	3
5,0	6	0,2	TH0605C6_FC	6	14	64	0,15	3
6,0	6	0,3	TH0606C7_FC	7	16	64	0,2	3
8,0	8	0,5	TH0808C9_FC	9	20	64	0,3	3
10,0	10	0,5	TH1010C12_FC	12	25	70	0,3	3
12,0	12	0,5	TH1212C15_FC	15	30	78	0,3	3
16,0	16	0,5	TH1616C18_FC	18	38	89	0,3	3



Micro, Two Flute

DC
 Diamond coated
 Micrograin Carbide
Tolerance
 D 0,3 - 3,0 -0,002 / -0,012
Shank
 Cylindrical h5, DIN6535 HA
Flute
 40° right hand spiral
 Center cutting
Field of application
 Graphite

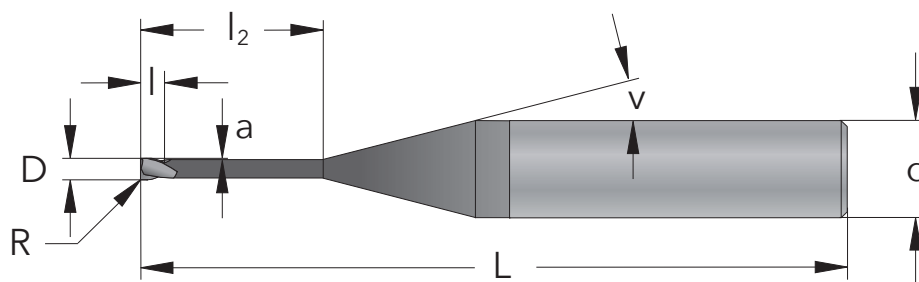

D mm	d mm	R mm	Part Number	l mm	l ₂ mm	L mm	a mm	v °	No. of Flutes
0,3	6	0,05	MG06003B1_DC	1,0	1,0	64		7	2
0,3	6	0,05	MG06003B1.4_DC	1,5	2,5	64	0,01	7	2
0,3	6	0,05	MG06003B1.5_DC	1,5	5,0	64	0,01	8	2
0,4	6	0,05	MG06004B1_DC	1,0	1,0	64		7	2
0,4	6	0,05	MG06004B1.4_DC	1,5	2,5	64	0,01	7	2
0,4	6	0,05	MG06004B1.5_DC	1,5	5,0	64	0,01	8	2
0,5	6	0,05	MG06005B1.3_DC	1,5	1,5	64		7	2
0,5	6	0,05	MG06005B1.4_DC	1,5	3,5	64	0,01	7	2
0,5	6	0,05	MG06005B1.5_DC	1,5	7,0	64	0,01	9	2
0,5	6	0,05	MG06005B1.6_DC	1,5	10,0	64	0,01	10	2
0,6	6	0,05	MG06006B1.8_DC	1,5	1,5	64		6	2
0,6	6	0,05	MG06006B1.9_DC	2,0	3,5	64	0,025	7	2
0,6	6	0,05	MG06006B2_DC	2,0	7,0	64	0,025	9	2
0,6	6	0,05	MG06006B2.1_DC	2,0	10,0	64	0,025	10	2
0,8	6	0,05	MG06008B1.8_DC	2,0	2,0	64		6	2
0,8	6	0,05	MG06008B1.9_DC	2,0	5,0	64	0,025	8	2
0,8	6	0,05	MG06008B1.95_DC	2,0	7,5	64	0,025	9	2
0,8	6	0,05	MG06008B2_DC	2,0	10,0	64	0,025	10	2
0,8	6	0,05	MG06008B2.1_DC	2,0	15,0	64	0,025	14	2
1,0	6	0,05	MG0601B2.5_DC	2,5	2,5	64		6	2
1,0	6	0,05	MG0601B2.9_DC	3,0	5,0	64	0,025	7	2
1,0	6	0,05	MG0601B2.95_DC	3,0	7,5	64	0,025	8	2
1,0	6	0,05	MG0601B3_DC	3,0	10,0	64	0,025	10	2
1,0	6	0,05	MG0601B3.1_DC	3,0	15,0	64	0,025	13	2
1,2	6	0,05	MG06012B2.9_DC	3,0	5,0	64	0,025	7	2
1,2	6	0,05	MG06012B3_DC	3,0	10,0	64	0,025	9	2
1,5	6	0,05	MG06015B2.9_DC	3,0	5,0	64	0,025	7	2
1,5	6	0,05	MG06015B2.95_DC	3,0	7,5	64	0,025	8	2
1,5	6	0,05	MG06015B3_DC	3,0	10,0	64	0,025	9	2
1,5	6	0,05	MG06015B3.1_DC	3,0	15,0	64	0,025	12	2
1,5	6	0,05	MG06015B3.2_DC	3,0	20,0	64	0,025	15	2

Micro, Two Flute, with Ball Nose

DC

Diamond coated
Micrograin Carbide

Tolerance

D 0,3 - 3,0 -0,002 / -0,012

Shank

Cylindrical h5, DIN6535 HA

Flute

40° right hand spiral

Field of application

Graphite

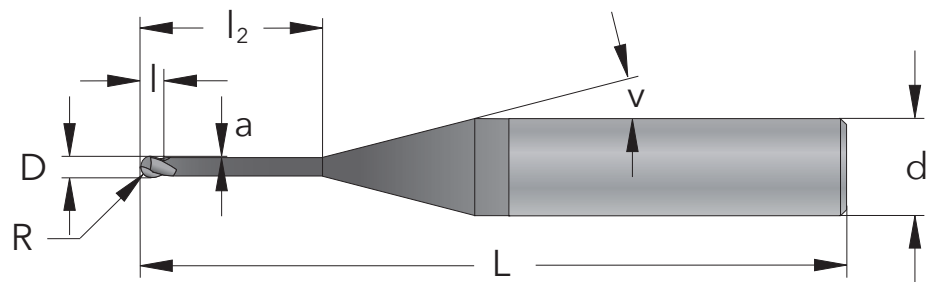

D mm	d mm	R mm	Part Number	l mm	l ₂ mm	L mm	a mm	v °	No. of Flutes
0,3	6	0,15	RG06003B1_DC	1,0	1,0	64		7	2
0,3	6	0,15	RG06003B1.4_DC	1,5	2,5	64	0,01	7	2
0,3	6	0,15	RG06003B1.5_DC	1,5	5,0	64	0,01	8	2
0,4	6	0,2	RG06004B1_DC	1,0	1,0	64		7	2
0,4	6	0,2	RG06004B1.4_DC	1,5	2,5	64	0,01	7	2
0,4	6	0,2	RG06004B1.5_DC	1,5	5,0	64	0,01	8	2
0,5	6	0,25	RG06005B1.3_DC	1,5	1,5	64		7	2
0,5	6	0,25	RG06005B1.4_DC	1,5	3,5	64	0,01	7	2
0,5	6	0,25	RG06005B1.5_DC	1,5	7,0	64	0,01	9	2
0,5	6	0,25	RG06005B1.6_DC	1,5	10,0	64	0,01	10	2
0,6	6	0,3	RG06006B1.8_DC	1,5	1,5	64		6	2
0,6	6	0,3	RG06006B1.9_DC	2,0	3,5	64	0,025	7	2
0,6	6	0,3	RG06006B2_DC	2,0	7,0	64	0,025	9	2
0,6	6	0,3	RG06006B2.1_DC	2,0	10,0	64	0,025	10	2
0,8	6	0,4	RG06008B1.8_DC	2,0	2,0	64		6	2
0,8	6	0,4	RG06008B1.9_DC	2,0	5,0	64	0,025	8	2
0,8	6	0,4	RG06008B1.95_DC	2,0	7,5	64	0,025	9	2
0,8	6	0,4	RG06008B2_DC	2,0	10,0	64	0,025	10	2
0,8	6	0,4	RG06008B2.1_DC	2,0	15,0	64	0,025	14	2
1,0	6	0,5	RG0601B2.5_DC	2,5	2,5	64		6	2
1,0	6	0,5	RG0601B2.9_DC	3,0	5,0	64	0,025	7	2
1,0	6	0,5	RG0601B2.95_DC	3,0	7,5	64	0,025	8	2
1,0	6	0,5	RG0601B3_DC	3,0	10,0	64	0,025	10	2
1,0	6	0,5	RG0601B3.1_DC	3,0	15,0	64	0,025	13	2
1,2	6	0,6	RG06012B2.9_DC	3,0	5,0	64	0,025	7	2
1,2	6	0,6	RG06012B3_DC	3,0	10,0	64	0,025	9	2
1,5	6	0,75	RG06015B2.9_DC	3,0	5,0	64	0,025	7	2
1,5	6	0,75	RG06015B2.95_DC	3,0	7,5	64	0,025	8	2
1,5	6	0,75	RG06015B3_DC	3,0	10,0	64	0,025	9	2
1,5	6	0,75	RG06015B3.1_DC	3,0	15,0	64	0,025	12	2
1,5	6	0,75	RG06015B3.2_DC	3,0	20,0	64	0,025	15	2

Three Flute, with Corner Radius

DC
 Diamond coated
 Micrograin Carbide
Tolerance
 D 1,0 - 3,0 -0,002 / -0,012
 D 4,0 - 6,0 -0,004 / -0,016
 D 7,0 - 10,0 -0,005 / -0,020
 D 11,0 - 18,0 -0,006 / -0,024
Shank
 Cylindrical h5, DIN6535 HA
Flute
 40° right hand spiral, center cutting
Field of application
 Graphite

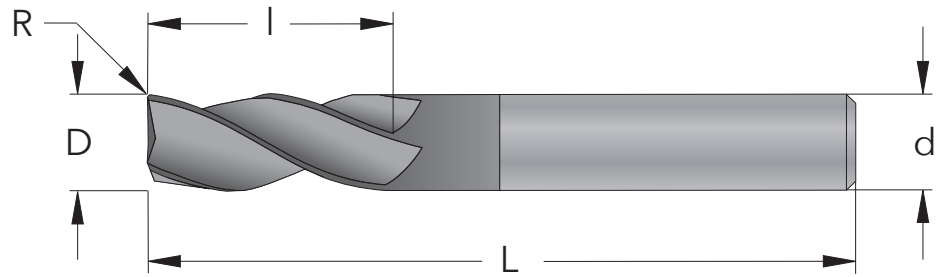

D mm	d mm	R mm	Part Number	l mm	L mm	No. of Flutes
2,0	3	0,1	MG0302C10_DC	10	50	3
3,0	3	0,1	MG0303C10_DC	10	50	3
4,0	4	0,2	MG0404C15_DC	15	60	3
5,0	5	0,2	MG0505C20_DC	20	60	3
6,0	6	0,3	MG0606C30_DC	30	78	3
8,0	8	0,3	MG0808C30_DC	30	78	3
10,0	10	0,3	MG1010C30_DC	30	78	3
12,0	12	0,3	MG1212C30_DC	30	89	3

Two Flute, with Corner Radius, Long Shank

DC
 Diamond coated
 Micrograin Carbide
Tolerance
 D 1,0 - 3,0 -0,002 / -0,012
 D 4,0 - 6,0 -0,004 / -0,016
 D 7,0 - 10,0 -0,005 / -0,020
 D 11,0 - 18,0 -0,006 / -0,024
Shank
 Cylindrical h5, DIN6535 HA
Flute
 40° right hand spiral, center cutting
Field of application
 Graphite

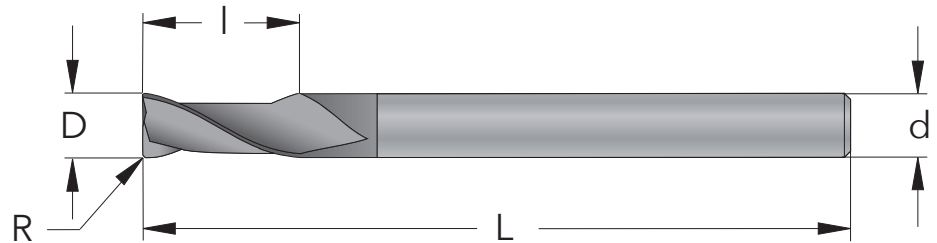

D mm	d mm	R mm	Part Number	l mm	L mm	No. of Flutes
4,0	4	0,3	MG0404B10L100_DC	10	100	2
5,0	5	0,5	MG0505B13L100_DC	13	100	2
6,0	6	0,5	MG0606B42L100_DC	42	100	2
6,0	6	0,5	MG0606B26L150_DC	26	150	2
8,0	8	0,5	MG0808B41L150_DC	41	150	2
10,0	10	0,5	MG1010B42L150_DC	42	150	2

Diamond **DIAMOND COATED END MILLS**

Two/Four Flute, with Corner Radius



DC

Diamond coated
Micrograin Carbide

Tolerance

D 1,0 - 3,0 -0,002 / -0,012

D 4,0 - 6,0 -0,004 / -0,016

D 7,0 - 10,0 -0,005 / -0,020

D 11,0 - 18,0 -0,006 / -0,024

Shank

Cylindrical h5, DIN6535 HA

Flute

40° right hand spiral, center cutting

Field of application

Graphite

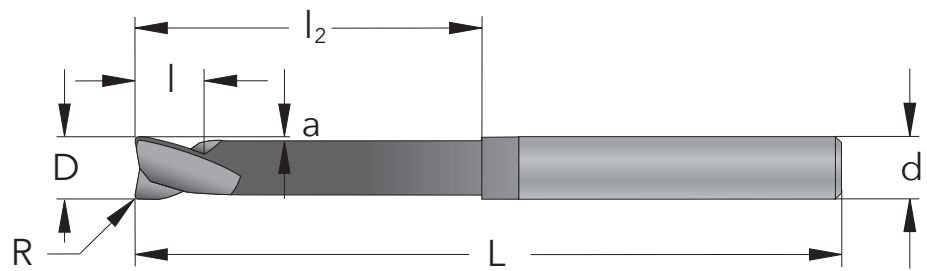

D mm	d mm	R mm	Part Number	l mm	l ₂ mm	L mm	a mm	No. of Flutes
2,0	3	0,1	MG0302B3_DC	3	10	50	0,1	2
3,0	6	0,1	MG0603B4_DC	4	10	50	0,1	2
4,0	6	0,2	MG0604D4_DC	4	10	50	0,1	4
5,0	6	0,2	MG0605D5_DC	5	10	50	0,15	4
6,0	6	0,3	MG0606D6_DC	6	10	50	0,2	4
8,0	8	0,3	MG0808D8_DC	8	15	64	0,3	4
10,0	10	0,3	MG1010D10_DC	10	20	78	0,3	4
12,0	12	0,3	MG1212D10_DC	10	20	78	0,3	4

Three Flute, with Ball Nose

DC
Diamond coated
Micrograin Carbide
Tolerance
D 1,0 - 3,0 -0,002 / -0,012
D 4,0 - 6,0 -0,004 / -0,016
D 7,0 - 10,0 -0,005 / -0,020
D 11,0 - 18,0 -0,006 / -0,024
Shank
Cylindrical h5, DIN6535 HA
Flute
40° right hand spiral
Field of application
Graphite

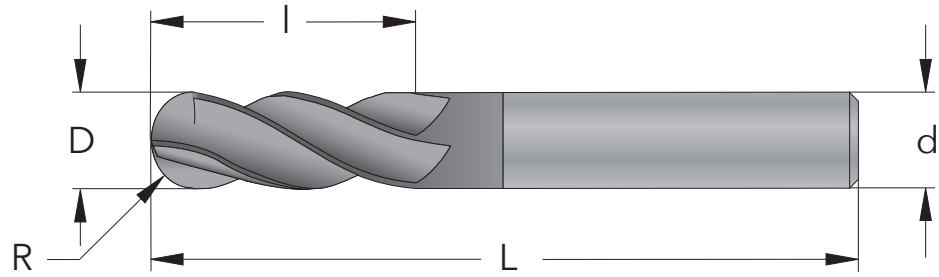

D mm	d mm	R mm	Part Number	l mm	L mm	No. of Flutes
2,0	3	1,0	RG0302C10_DC	10	50	3
3,0	3	1,5	RG0303C10_DC	10	50	3
4,0	4	2,0	RG0404C15_DC	15	60	3
5,0	5	2,5	RG0505C20_DC	20	60	3
6,0	6	3,0	RG0606C30_DC	30	78	3
8,0	8	4,0	RG0808C30_DC	30	78	3
10,0	10	5,0	RG1010C30_DC	30	78	3
12,0	12	6,0	RG1212C30_DC	30	89	3

Two Flute, with Ball Nose, Long Shank

DC
Diamond coated
Micrograin Carbide
Tolerance
D 1,0 - 3,0 -0,002 / -0,012
D 4,0 - 6,0 -0,004 / -0,016
D 7,0 - 10,0 -0,005 / -0,020
D 11,0 - 18,0 -0,006 / -0,024
Shank
Cylindrical h5, DIN6535 HA
Flute
40° right hand spiral
Field of application
Graphite

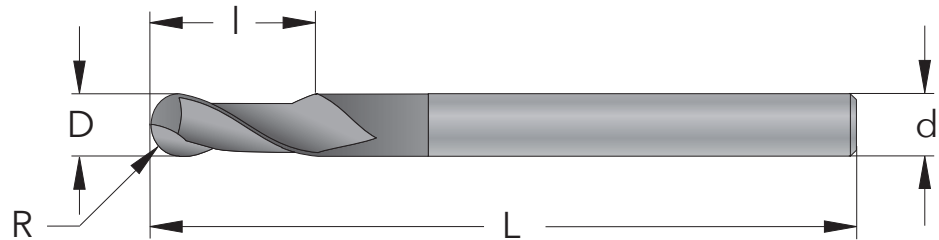

D mm	d mm	R mm	Part Number	l mm	L mm	No. of Flutes
2,0	3	1,0	RG0302B6L100_DC	6	100	2
3,0	3	1,5	RG0303B16L100_DC	16	100	2
4,0	4	2,0	RG0404B16L100_DC	16	100	2
6,0	6	3,0	RG0606B42L100_DC	42	100	2
6,0	6	3,0	RG0606B42L150_DC	42	150	2
8,0	8	4,0	RG0808B42L100_DC	42	100	2
8,0	8	4,0	RG0808B42L150_DC	42	150	2
10,0	10	5,0	RG1010B45L150_DC	45	150	2

Two/Four Flute, with Ball Nose

DC

Diamond coated
Micrograin Carbide

Tolerance

D 1,0 - 3,0 -0,002 / -0,012

D 4,0 - 6,0 -0,004 / -0,016

D 7,0 - 10,0 -0,005 / -0,020

D 11,0 - 18,0 -0,006 / -0,024

Shank

Cylindrical h5, DIN6535 HA

Flute

40° right hand spiral

Field of application

Graphite

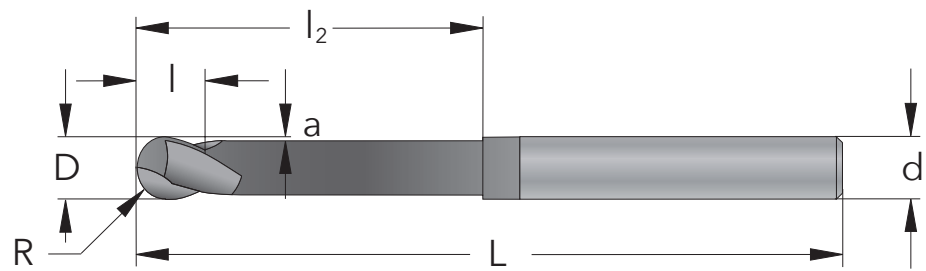

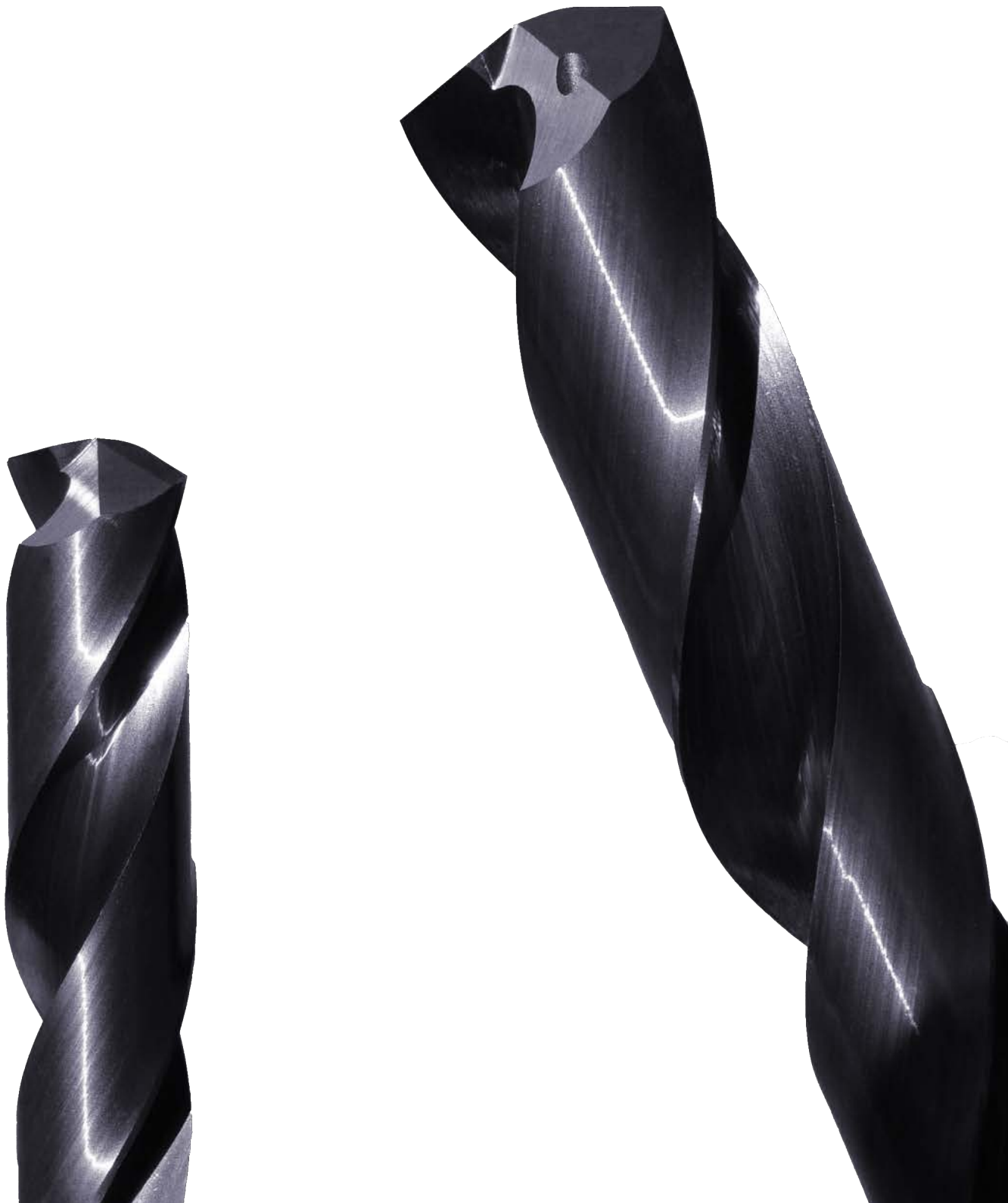

D mm	d mm	R mm	Part Number	l mm	l ₂ mm	L mm	a mm	No. of Flutes
2,0	3	1,0	RG0302B3_DC	3	10	50	0,1	2
3,0	6	1,5	RG0603B4_DC	4	10	50	0,1	2
4,0	6	2,0	RG0604D4_DC	4	10	50	0,1	4
5,0	6	2,5	RG0605D5_DC	5	10	50	0,15	4
6,0	6	3,0	RG0606D6_DC	6	10	50	0,2	4
8,0	8	4,0	RG0808D8_DC	8	15	64	0,3	4
10,0	10	5,0	RG1010D10_DC	10	20	78	0,3	4
12,0	12	6,0	RG1212D10_DC	10	20	78	0,3	4



SOLID CARBIDE DRILLS

CONTENTS

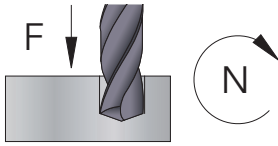

Technical Information	116	
Solid Carbide Drills	118	
Solid Carbide Drills with Internal Coolant	122	

Cutting Speed (V_c) and Material Factor (F_m)

MATERIAL		Hardness HB	Tensile Strength N/mm ²	Cutting Speed (V_c) m/min	Material Factor (F_m)
Steel	Low carbon, C < 0,25%	< 120	< 400	80 - 120	1,2
	Medium carbon, C < 0,55%	< 200	< 700	70 - 110	1,1
	High carbon, C < 0,85%	< 250	< 850	60 - 100	1,0
	Low alloy	< 250	< 850	60 - 100	1,0
	High alloy	< 350	< 1200	40 - 60	0,9
	Hardened, HRC < 45			30 - 50	0,8
	Hardened, HRC < 55			20 - 30	0,7
	Hardened, HRC < 65			15 - 25	0,6
Cast iron	Lamellar graphite	< 150	< 500	70 - 110	1,2
	Lamellar graphite	< 300	< 1000	60 - 100	1,1
	Nodular graphite, malleable	< 200	< 700	50 - 80	1,0
	Nodular graphite, malleable	< 300	< 1000	40 - 70	0,9
Stainless steel	Free machining	< 250	< 850	40 - 55	1,0
	Austenitic	< 250	< 850	30 - 45	0,9
	Ferritic and austenitic	< 300	< 1000	25 - 40	0,8
Titanium	Unalloyed	< 200	< 700	35 - 50	0,8
	Alloyed	< 270	< 900	25 - 40	0,7
	Alloyed	< 350	< 1250	20 - 35	0,6
Nickel	Unalloyed	< 150	< 500	40 - 55	0,8
	Alloyed	< 270	< 900	25 - 35	0,7
	Alloyed	< 350	< 1250	20 - 30	0,6
Copper	Unalloyed	< 100	< 350	80 - 160	1,0
	Brass, bronze	< 200	< 700	70 - 150	1,0
	High strength bronze	< 470	< 1500	50 - 70	0,8
Aluminium	Unalloyed	< 100	< 350	200 - 300	1,4
	Alloyed, Si < 0.5%	< 150	< 500	150 - 250	1,3
	Alloyed, Si < 10%	< 120	< 400	100 - 200	1,2
	Alloyed, Si > 10%	< 120	< 400	80 - 160	1,1
Inconel	718	< 370		20 - 30	0,6
Graphite				100 - 200	1,0

■ 20% higher cutting speed is recommended for drill with internal coolant.

Code Key

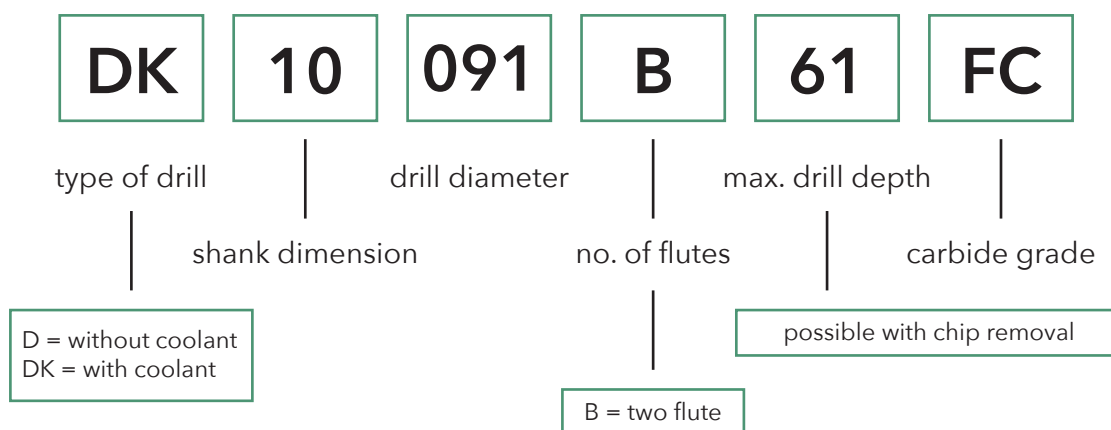

Diameter Factor (F_d)

D	Diameter Factor (F_d)		
	3xD	5xD	8xD
3,0	0,12	0,10	0,08
4,0	0,14	0,11	0,10
5,0	0,17	0,14	0,12
6,0	0,20	0,16	0,14
8,0	0,26	0,21	0,18
10,0	0,34	0,27	0,24
12,0	0,38	0,30	0,27
14,0	0,41	0,33	0,29
16,0	0,44	0,35	0,31
18,0	0,46	0,37	0,32
20,0	0,50	0,40	0,35

Example

Drilling with D10100B47 FC (3xD)

Carbon Steel, up to 700 N/mm²

D = 10,0 mm

$F_n = 1,1 \times 0,34 = 0,37$ mm/r

$n = (90 \times 1000) / (\pi \times 10) = 2865$ rpm

$V_f = 0,37 \times 2865 = 1060$ mm/min

$$F_n = F_m \times F_d$$

$$n = \frac{V_c \times 1000}{\pi \times D}$$

D = drill diameter (mm)

F_n = feed / rev. (mm/r)

n = spindle speed (rpm)

V_c = cutting speed (m/min)

V_f = table feed (mm/min)

$$V_f = F_n \times n$$

Carbide Grades



Super Micrograin Carbide with TiAlN coating.
Allround Grade with high heat resistance.
Use cutting data according to the tables.

3xD, 5xD

DIN 6537
FC
 TiAlN coated
 Super Micrograin Carbide
Tolerance
 D m7
Shank
 Cylindrical h6, DIN 6535 HA
Flute
 30° right hand spiral
 140° point angle
Field of application
 All types of steel

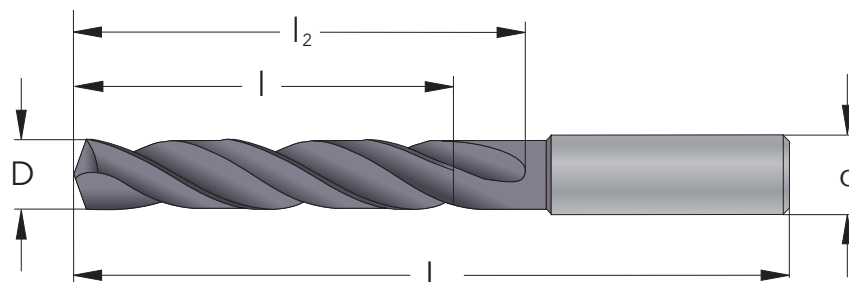

D mm	d mm	Part Number	Type	l mm	l ₂ mm	L mm
3,0	6	D06030B20_FC	3xD	14	20	62
3,0	6	D06030B28_FC	5xD	23	28	66
3,1	6	D06031B20_FC	3xD	14	20	62
3,1	6	D06031B28_FC	5xD	23	28	66
3,2	6	D06032B20_FC	3xD	14	20	62
3,2	6	D06032B28_FC	5xD	23	28	66
3,3	6	D06033B20_FC	3xD	14	20	62
3,3	6	D06033B28_FC	5xD	23	28	66
3,4	6	D06034B20_FC	3xD	14	20	62
3,4	6	D06034B28_FC	5xD	23	28	66
3,5	6	D06035B20_FC	3xD	14	20	62
3,5	6	D06035B28_FC	5xD	23	28	66
3,6	6	D06036B20_FC	3xD	14	20	62
3,6	6	D06036B28_FC	5xD	23	28	66
3,7	6	D06037B20_FC	3xD	14	20	62
3,7	6	D06037B28_FC	5xD	23	28	66
3,8	6	D06038B24_FC	3xD	17	24	66
3,8	6	D06038B36_FC	5xD	29	36	74
3,9	6	D06039B24_FC	3xD	17	24	66
3,9	6	D06039B36_FC	5xD	29	36	74
4,0	6	D06040B24_FC	3xD	17	24	66
4,0	6	D06040B36_FC	5xD	29	36	74
4,1	6	D06041B24_FC	3xD	17	24	66
4,1	6	D06041B36_FC	5xD	29	36	74
4,2	6	D06042B24_FC	3xD	17	24	66
4,2	6	D06042B36_FC	5xD	29	36	74
4,3	6	D06043B24_FC	3xD	17	24	66
4,3	6	D06043B36_FC	5xD	29	36	74
4,4	6	D06044B24_FC	3xD	17	24	66
4,4	6	D06044B36_FC	5xD	29	36	74
4,5	6	D06045B24_FC	3xD	17	24	66
4,5	6	D06045B36_FC	5xD	29	36	74
4,6	6	D06046B24_FC	3xD	17	24	66
4,6	6	D06046B36_FC	5xD	29	36	74
4,7	6	D06047B24_FC	3xD	17	24	66
4,7	6	D06047B36_FC	5xD	29	36	74
4,8	6	D06048B28_FC	3xD	20	28	66
4,8	6	D06048B44_FC	5xD	35	44	82
4,9	6	D06049B28_FC	3xD	20	28	66
4,9	6	D06049B44_FC	5xD	35	44	82
5,0	6	D06050B28_FC	3xD	20	28	66
5,0	6	D06050B44_FC	5xD	35	44	82
5,1	6	D06051B28_FC	3xD	20	28	66
5,1	6	D06051B44_FC	5xD	35	44	82
5,2	6	D06052B28_FC	3xD	20	28	66
5,2	6	D06052B44_FC	5xD	35	44	82
5,3	6	D06053B28_FC	3xD	20	28	66

D mm	d mm	Part Number	Type	l mm	l ₂ mm	L mm
5,3	6	D06053B44_FC	5xD	35	44	82
5,4	6	D06054B28_FC	3xD	20	28	66
5,4	6	D06054B44_FC	5xD	35	44	82
5,5	6	D06055B28_FC	3xD	20	28	66
5,5	6	D06055B44_FC	5xD	35	44	82
5,6	6	D06056B28_FC	3xD	20	28	66
5,6	6	D06056B44_FC	5xD	35	44	82
5,7	6	D06057B28_FC	3xD	20	28	66
5,7	6	D06057B44_FC	5xD	35	44	82
5,8	6	D06058B28_FC	3xD	20	28	66
5,8	6	D06058B44_FC	5xD	35	44	82
5,9	6	D06059B28_FC	3xD	20	28	66
5,9	6	D06059B44_FC	5xD	35	44	82
6,0	6	D06060B28_FC	3xD	20	28	66
6,0	6	D06060B44_FC	5xD	35	44	82
6,1	8	D08061B34_FC	3xD	24	34	79
6,1	8	D08061B53_FC	5xD	43	53	91
6,2	8	D08062B34_FC	3xD	24	34	79
6,2	8	D08062B53_FC	5xD	43	53	91
6,3	8	D08063B34_FC	3xD	24	34	79
6,3	8	D08063B53_FC	5xD	43	53	91
6,4	8	D08064B34_FC	3xD	24	34	79
6,4	8	D08064B53_FC	5xD	43	53	91
6,5	8	D08065B34_FC	3xD	24	34	79
6,5	8	D08065B53_FC	5xD	43	53	91
6,6	8	D08066B34_FC	3xD	24	34	79
6,6	8	D08066B53_FC	5xD	43	53	91
6,7	8	D08067B34_FC	3xD	24	34	79
6,7	8	D08067B53_FC	5xD	43	53	91
6,8	8	D08068B34_FC	3xD	24	34	79
6,8	8	D08068B53_FC	5xD	43	53	91
6,9	8	D08069B34_FC	3xD	24	34	79
6,9	8	D08069B53_FC	5xD	43	53	91
7,0	8	D08070B34_FC	3xD	24	34	79
7,0	8	D08070B53_FC	5xD	43	53	91
7,1	8	D08071B41_FC	3xD	29	41	79
7,1	8	D08071B53_FC	5xD	43	53	91
7,2	8	D08072B41_FC	3xD	29	41	79
7,2	8	D08072B53_FC	5xD	43	53	91
7,3	8	D08073B41_FC	3xD	29	41	79
7,3	8	D08073B53_FC	5xD	43	53	91
7,4	8	D08074B41_FC	3xD	29	41	79
7,4	8	D08074B53_FC	5xD	43	53	91
7,5	8	D08075B41_FC	3xD	29	41	79
7,5	8	D08075B53_FC	5xD	43	53	91
7,6	8	D08076B41_FC	3xD	29	41	79
7,6	8	D08076B53_FC	5xD	43	53	91
7,7	8	D08077B41_FC	3xD	29	41	79
7,7	8	D08077B53_FC	5xD	43	53	91
7,8	8	D08078B41_FC	3xD	29	41	79
7,8	8	D08078B53_FC	5xD	43	53	91
7,9	8	D08079B41_FC	3xD	29	41	79
7,9	8	D08079B53_FC	5xD	43	53	91
8,0	8	D08080B41_FC	3xD	29	41	79
8,0	8	D08080B53_FC	5xD	43	53	91
8,1	10	D10081B47_FC	3xD	35	47	89
8,1	10	D10081B61_FC	5xD	49	61	103
8,2	10	D10082B47_FC	3xD	35	47	89
8,2	10	D10082B61_FC	5xD	49	61	103
8,3	10	D10083B47_FC	3xD	35	47	89
8,3	10	D10083B61_FC	5xD	49	61	103

3xD, 5xD

D mm	d mm	Part Number	Type	l mm	l ₂ mm	L mm
8,4	10	D10084B47_FC	3xD	35	47	89
8,4	10	D10084B61_FC	5xD	49	61	103
8,5	10	D10085B47_FC	3xD	35	47	89
8,5	10	D10085B61_FC	5xD	49	61	103
8,6	10	D10086B47_FC	3xD	35	47	89
8,6	10	D10086B61_FC	5xD	49	61	103
8,7	10	D10087B47_FC	3xD	35	47	89
8,7	10	D10087B61_FC	5xD	49	61	103
8,8	10	D10088B47_FC	3xD	35	47	89
8,8	10	D10088B61_FC	5xD	49	61	103
8,9	10	D10089B47_FC	3xD	35	47	89
8,9	10	D10089B61_FC	5xD	49	61	103
9,0	10	D10090B47_FC	3xD	35	47	89
9,0	10	D10090B61_FC	5xD	49	61	103
9,1	10	D10091B47_FC	3xD	35	47	89
9,1	10	D10091B61_FC	5xD	49	61	103
9,2	10	D10092B47_FC	3xD	35	47	89
9,2	10	D10092B61_FC	5xD	49	61	103
9,3	10	D10093B47_FC	3xD	35	47	89
9,3	10	D10093B61_FC	5xD	49	61	103
9,4	10	D10094B47_FC	3xD	35	47	89
9,4	10	D10094B61_FC	5xD	49	61	103
9,5	10	D10095B47_FC	3xD	35	47	89
9,5	10	D10095B61_FC	5xD	49	61	103
9,6	10	D10096B47_FC	3xD	35	47	89
9,6	10	D10096B61_FC	5xD	49	61	103
9,7	10	D10097B47_FC	3xD	35	47	89
9,7	10	D10097B61_FC	5xD	49	61	103
9,8	10	D10098B47_FC	3xD	35	47	89
9,8	10	D10098B61_FC	5xD	49	61	103
9,9	10	D10099B47_FC	3xD	35	47	89
9,9	10	D10099B61_FC	5xD	49	61	103
10,0	10	D10100B47_FC	3xD	35	47	89
10,0	10	D10100B61_FC	5xD	49	61	103
10,1	12	D12101B55_FC	3xD	40	55	102
10,1	12	D12101B71_FC	5xD	56	71	118
10,2	12	D12102B55_FC	3xD	40	55	102
10,2	12	D12102B71_FC	5xD	56	71	118
10,3	12	D12103B55_FC	3xD	40	55	102
10,3	12	D12103B71_FC	5xD	56	71	118
10,4	12	D12104B55_FC	3xD	40	55	102
10,4	12	D12104B71_FC	5xD	56	71	118
10,5	12	D12105B55_FC	3xD	40	55	102
10,5	12	D12105B71_FC	5xD	56	71	118
10,6	12	D12106B55_FC	3xD	40	55	102
10,6	12	D12106B71_FC	5xD	56	71	118
10,7	12	D12107B55_FC	3xD	40	55	102
10,7	12	D12107B71_FC	5xD	56	71	118
10,8	12	D12108B55_FC	3xD	40	55	102
10,8	12	D12108B71_FC	5xD	56	71	118
10,9	12	D12109B55_FC	3xD	40	55	102
10,9	12	D12109B71_FC	5xD	56	71	118
11,0	12	D12110B55_FC	3xD	40	55	102
11,0	12	D12110B71_FC	5xD	56	71	118
11,1	12	D12111B55_FC	3xD	40	55	102
11,1	12	D12111B71_FC	5xD	56	71	118
11,2	12	D12112B55_FC	3xD	40	55	102
11,2	12	D12112B71_FC	5xD	56	71	118
11,3	12	D12113B55_FC	3xD	40	55	102
11,3	12	D12113B71_FC	5xD	56	71	118
11,4	12	D12114B55_FC	3xD	40	55	102

D mm	d mm	Part Number	Type	l mm	l ₂ mm	L mm
11,4	12	D12114B71_FC	5xD	56	71	118
11,5	12	D12115B55_FC	3xD	40	55	102
11,5	12	D12115B71_FC	5xD	56	71	118
11,6	12	D12116B55_FC	3xD	40	55	102
11,6	12	D12116B71_FC	5xD	56	71	118
11,7	12	D12117B55_FC	3xD	40	55	102
11,7	12	D12117B71_FC	5xD	56	71	118
11,8	12	D12118B55_FC	3xD	40	55	102
11,8	12	D12118B71_FC	5xD	56	71	118
11,9	12	D12119B55_FC	3xD	40	55	102
11,9	12	D12119B71_FC	5xD	56	71	118
12,0	12	D12120B55_FC	3xD	40	55	102
12,0	12	D12120B71_FC	5xD	56	71	118
12,5	14	D14125B60_FC	3xD	43	60	107
12,5	14	D14125B77_FC	5xD	60	77	124
13,0	14	D14130B60_FC	3xD	43	60	107
13,0	14	D14130B77_FC	5xD	60	77	124
13,5	14	D14135B60_FC	3xD	43	60	107
13,5	14	D14135B77_FC	5xD	60	77	124
14,0	14	D14140B60_FC	3xD	43	60	107
14,0	14	D14140B77_FC	5xD	60	77	124
14,5	16	D16145B65_FC	3xD	45	65	115
14,5	16	D16145B83_FC	5xD	63	83	133
15,0	16	D16150B65_FC	3xD	45	65	115
15,0	16	D16150B83_FC	5xD	63	83	133
15,5	16	D16155B65_FC	3xD	45	65	115
15,5	16	D16155B83_FC	5xD	63	83	133
16,0	16	D16160B65_FC	3xD	45	65	115
16,0	16	D16160B83_FC	5xD	63	83	133
16,5	18	D18165B73_FC	3xD	51	73	123
16,5	18	D18165B93_FC	5xD	71	93	143
17,0	18	D18170B73_FC	3xD	51	73	123
17,0	18	D18170B93_FC	5xD	71	93	143
17,5	18	D18175B73_FC	3xD	51	73	123
17,5	18	D18175B93_FC	5xD	71	93	143
18,0	18	D18180B73_FC	3xD	51	73	123
18,0	18	D18180B93_FC	5xD	71	93	143
18,5	20	D20185B79_FC	3xD	55	79	131
18,5	20	D20185B101_FC	5xD	77	101	153
19,0	20	D20190B79_FC	3xD	55	79	131
19,0	20	D20190B101_FC	5xD	77	101	153
19,5	20	D20195B79_FC	3xD	55	79	131
19,5	20	D20195B101_FC	5xD	77	101	153
20,0	20	D20200B79_FC	3xD	55	79	131
20,0	20	D20200B101_FC	5xD	77	101	153

with Internal Coolant, 3xD, 5xD, 8xD

DIN 6537
FC
 TiAlN coated
 Super Micrograin Carbide
Tolerance
 D m7
Shank
 Cylindrical h6, DIN 6535 HA
Flute
 30° right hand spiral
 140° point angle
Field of application
 All types of steel

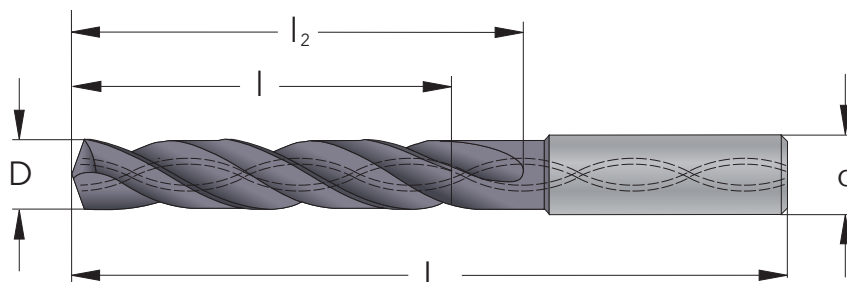

D mm	d mm	Part Number	Type	l mm	l ₂ mm	L mm
3,0	6	DK06030B20_FC	3xD	14	20	62
3,0	6	DK06030B28_FC	5xD	23	28	66
3,0	6	DK06030B50_FC	8xD	38	50	95
3,1	6	DK06031B20_FC	3xD	14	20	62
3,1	6	DK06031B28_FC	5xD	23	28	66
3,2	6	DK06032B20_FC	3xD	14	20	62
3,2	6	DK06032B28_FC	5xD	23	28	66
3,3	6	DK06033B20_FC	3xD	14	20	62
3,3	6	DK06033B28_FC	5xD	23	28	66
3,4	6	DK06034B20_FC	3xD	14	20	62
3,4	6	DK06034B28_FC	5xD	23	28	66
3,5	6	DK06035B20_FC	3xD	14	20	62
3,5	6	DK06035B28_FC	5xD	23	28	66
3,5	6	DK06035B50_FC	8xD	38	50	95
3,6	6	DK06036B20_FC	3xD	14	20	62
3,6	6	DK06036B28_FC	5xD	23	28	66
3,7	6	DK06037B20_FC	3xD	14	20	62
3,7	6	DK06037B28_FC	5xD	23	28	66
3,8	6	DK06038B24_FC	3xD	17	24	66
3,8	6	DK06038B36_FC	5xD	29	36	74
3,9	6	DK06039B24_FC	3xD	17	24	66
3,9	6	DK06039B36_FC	5xD	29	36	74
4,0	6	DK06040B24_FC	3xD	17	24	66
4,0	6	DK06040B36_FC	5xD	29	36	74
4,0	6	DK06040B50_FC	8xD	38	50	95
4,1	6	DK06041B24_FC	3xD	17	24	66
4,1	6	DK06041B36_FC	5xD	29	36	74
4,2	6	DK06042B24_FC	3xD	17	24	66
4,2	6	DK06042B36_FC	5xD	29	36	74
4,3	6	DK06043B24_FC	3xD	17	24	66
4,3	6	DK06043B36_FC	5xD	29	36	74
4,4	6	DK06044B24_FC	3xD	17	24	66
4,4	6	DK06044B36_FC	5xD	29	36	74
4,5	6	DK06045B24_FC	3xD	17	24	66
4,5	6	DK06045B36_FC	5xD	29	36	74
4,5	6	DK06045B50_FC	8xD	38	50	95
4,6	6	DK06046B24_FC	3xD	17	24	66
4,6	6	DK06046B36_FC	5xD	29	36	74
4,7	6	DK06047B24_FC	3xD	17	24	66
4,7	6	DK06047B36_FC	5xD	29	36	74
4,8	6	DK06048B28_FC	3xD	20	28	66
4,8	6	DK06048B44_FC	5xD	35	44	82
4,9	6	DK06049B28_FC	3xD	20	28	66
4,9	6	DK06049B44_FC	5xD	35	44	82
5,0	6	DK06050B28_FC	3xD	20	28	66
5,0	6	DK06050B44_FC	5xD	35	44	82
5,0	6	DK06050B50_FC	8xD	38	50	95

D mm	d mm	Part Number	Type	l mm	l ₂ mm	L mm
5,1	6	DK06051B28_FC	3xD	20	28	66
5,1	6	DK06051B44_FC	5xD	35	44	82
5,2	6	DK06052B28_FC	3xD	20	28	66
5,2	6	DK06052B44_FC	5xD	35	44	82
5,3	6	DK06053B28_FC	3xD	20	28	66
5,3	6	DK06053B44_FC	5xD	35	44	82
5,4	6	DK06054B28_FC	3xD	20	28	66
5,4	6	DK06054B44_FC	5xD	35	44	82
5,5	6	DK06055B28_FC	3xD	20	28	66
5,5	6	DK06055B44_FC	5xD	35	44	82
5,5	6	DK06055B50_FC	8xD	38	50	95
5,6	6	DK06056B28_FC	3xD	20	28	66
5,6	6	DK06056B44_FC	5xD	35	44	82
5,7	6	DK06057B28_FC	3xD	20	28	66
5,7	6	DK06057B44_FC	5xD	35	44	82
5,8	6	DK06058B28_FC	3xD	20	28	66
5,8	6	DK06058B44_FC	5xD	35	44	82
5,9	6	DK06059B28_FC	3xD	20	28	66
5,9	6	DK06059B44_FC	5xD	35	44	82
6,0	6	DK06060B28_FC	3xD	20	28	66
6,0	6	DK06060B44_FC	5xD	35	44	82
6,0	6	DK06060B50_FC	8xD	38	50	95
6,1	8	DK08061B34_FC	3xD	24	34	79
6,1	8	DK08061B53_FC	5xD	43	53	91
6,2	8	DK08062B34_FC	3xD	24	34	79
6,2	8	DK08062B53_FC	5xD	43	53	91
6,3	8	DK08063B34_FC	3xD	24	34	79
6,3	8	DK08063B53_FC	5xD	43	53	91
6,4	8	DK08064B34_FC	3xD	24	34	79
6,4	8	DK08064B53_FC	5xD	43	53	91
6,5	8	DK08065B34_FC	3xD	24	34	79
6,5	8	DK08065B53_FC	5xD	43	53	91
6,5	8	DK08065B66_FC	8xD	50	66	114
6,6	8	DK08066B34_FC	3xD	24	34	79
6,6	8	DK08066B53_FC	5xD	43	53	91
6,7	8	DK08067B34_FC	3xD	24	34	79
6,7	8	DK08067B53_FC	5xD	43	53	91
6,8	8	DK08068B34_FC	3xD	24	34	79
6,8	8	DK08068B53_FC	5xD	43	53	91
6,9	8	DK08069B34_FC	3xD	24	34	79
6,9	8	DK08069B53_FC	5xD	43	53	91
7,0	8	DK08070B34_FC	3xD	24	34	79
7,0	8	DK08070B53_FC	5xD	43	53	91
7,0	8	DK08070B76_FC	8xD	60	76	114
7,1	8	DK08071B41_FC	3xD	29	41	79
7,1	8	DK08071B53_FC	5xD	43	53	91
7,2	8	DK08072B41_FC	3xD	29	41	79
7,2	8	DK08072B53_FC	5xD	43	53	91
7,3	8	DK08073B41_FC	3xD	29	41	79
7,3	8	DK08073B53_FC	5xD	43	53	91
7,4	8	DK08074B41_FC	3xD	29	41	79
7,4	8	DK08074B53_FC	5xD	43	53	91
7,5	8	DK08075B41_FC	3xD	29	41	79
7,5	8	DK08075B53_FC	5xD	43	53	91
7,5	8	DK08075B76_FC	8xD	60	76	114
7,6	8	DK08076B41_FC	3xD	29	41	79
7,6	8	DK08076B53_FC	5xD	43	53	91
7,7	8	DK08077B41_FC	3xD	29	41	79
7,7	8	DK08077B53_FC	5xD	43	53	91
7,8	8	DK08078B41_FC	3xD	29	41	79
7,8	8	DK08078B53_FC	5xD	43	53	91

with Internal Coolant, 3xD, 5xD, 8xD

D mm	d mm	Part Number	Type	l mm	l ₂ mm	L mm
7,9	8	DK08079B41_FC	3xD	29	41	79
7,9	8	DK08079B53_FC	5xD	43	53	91
8,0	8	DK08080B41_FC	3xD	29	41	79
8,0	8	DK08080B53_FC	5xD	43	53	91
8,0	8	DK08080B76_FC	8xD	60	76	114
8,1	10	DK10081B47_FC	3xD	35	47	89
8,1	10	DK10081B61_FC	5xD	49	61	103
8,2	10	DK10082B47_FC	3xD	35	47	89
8,2	10	DK10082B61_FC	5xD	49	61	103
8,3	10	DK10083B47_FC	3xD	35	47	89
8,3	10	DK10083B61_FC	5xD	49	61	103
8,4	10	DK10084B47_FC	3xD	35	47	89
8,4	10	DK10084B61_FC	5xD	49	61	103
8,5	10	DK10085B47_FC	3xD	35	47	89
8,5	10	DK10085B61_FC	5xD	49	61	103
8,5	10	DK10085B87_FC	8xD	68	87	142
8,6	10	DK10086B47_FC	3xD	35	47	89
8,6	10	DK10086B61_FC	5xD	49	61	103
8,7	10	DK10087B47_FC	3xD	35	47	89
8,7	10	DK10087B61_FC	5xD	49	61	103
8,8	10	DK10088B47_FC	3xD	35	47	89
8,8	10	DK10088B61_FC	5xD	49	61	103
8,9	10	DK10089B47_FC	3xD	35	47	89
8,9	10	DK10089B61_FC	5xD	49	61	103
9,0	10	DK10090B47_FC	3xD	35	47	89
9,0	10	DK10090B61_FC	5xD	49	61	103
9,0	10	DK10090B87_FC	8xD	68	87	142
9,1	10	DK10091B47_FC	3xD	35	47	89
9,1	10	DK10091B61_FC	5xD	49	61	103
9,2	10	DK10092B47_FC	3xD	35	47	89
9,2	10	DK10092B61_FC	5xD	49	61	103
9,3	10	DK10093B47_FC	3xD	35	47	89
9,3	10	DK10093B61_FC	5xD	49	61	103
9,4	10	DK10094B47_FC	3xD	35	47	89
9,4	10	DK10094B61_FC	5xD	49	61	103
9,5	10	DK10095B47_FC	3xD	35	47	89
9,5	10	DK10095B61_FC	5xD	49	61	103
9,5	10	DK10095B95_FC	8xD	76	95	142
9,6	10	DK10096B47_FC	3xD	35	47	89
9,6	10	DK10096B61_FC	5xD	49	61	103
9,7	10	DK10097B47_FC	3xD	35	47	89
9,7	10	DK10097B61_FC	5xD	49	61	103
9,8	10	DK10098B47_FC	3xD	35	47	89
9,8	10	DK10098B61_FC	5xD	49	61	103
9,9	10	DK10099B47_FC	3xD	35	47	89
9,9	10	DK10099B61_FC	5xD	49	61	103
10,0	10	DK10100B47_FC	3xD	35	47	89
10,0	10	DK10100B61_FC	5xD	49	61	103
10,0	10	DK10100B95_FC	8xD	76	95	142
10,1	12	DK12101B55_FC	3xD	40	55	102
10,1	12	DK12101B71_FC	5xD	56	71	118
10,2	12	DK12102B55_FC	3xD	40	55	102
10,2	12	DK12102B71_FC	5xD	56	71	118
10,3	12	DK12103B55_FC	3xD	40	55	102
10,3	12	DK12103B71_FC	5xD	56	71	118
10,4	12	DK12104B55_FC	3xD	40	55	102
10,4	12	DK12104B71_FC	5xD	56	71	118
10,5	12	DK12105B55_FC	3xD	40	55	102
10,5	12	DK12105B71_FC	5xD	56	71	118
10,5	12	DK12105B106_FC	8xD	82	106	162
10,6	12	DK12106B55_FC	3xD	40	55	102

D mm	d mm	Part Number	Type	l mm	l ₂ mm	L mm
10,6	12	DK12106B71_FC	5xD	56	71	118
10,7	12	DK12107B55_FC	3xD	40	55	102
10,7	12	DK12107B71_FC	5xD	56	71	118
10,8	12	DK12108B55_FC	3xD	40	55	102
10,8	12	DK12108B71_FC	5xD	56	71	118
10,9	12	DK12109B55_FC	3xD	40	55	102
10,9	12	DK12109B71_FC	5xD	56	71	118
11,0	12	DK12110B55_FC	3xD	40	55	102
11,0	12	DK12110B71_FC	5xD	56	71	118
11,0	12	DK12110B106_FC	8xD	82	106	162
11,1	12	DK12111B55_FC	3xD	40	55	102
11,1	12	DK12111B71_FC	5xD	56	71	118
11,2	12	DK12112B55_FC	3xD	40	55	102
11,2	12	DK12112B71_FC	5xD	56	71	118
11,3	12	DK12113B55_FC	3xD	40	55	102
11,3	12	DK12113B71_FC	5xD	56	71	118
11,4	12	DK12114B55_FC	3xD	40	55	102
11,4	12	DK12114B71_FC	5xD	56	71	118
11,5	12	DK12115B55_FC	3xD	40	55	102
11,5	12	DK12115B71_FC	5xD	56	71	118
11,5	12	DK12115B114_FC	8xD	90	114	162
11,6	12	DK12116B55_FC	3xD	40	55	102
11,6	12	DK12116B71_FC	5xD	56	71	118
11,7	12	DK12117B55_FC	3xD	40	55	102
11,7	12	DK12117B71_FC	5xD	56	71	118
11,8	12	DK12118B55_FC	3xD	40	55	102
11,8	12	DK12118B71_FC	5xD	56	71	118
11,9	12	DK12119B55_FC	3xD	40	55	102
11,9	12	DK12119B71_FC	5xD	56	71	118
12,0	12	DK12120B55_FC	3xD	40	55	102
12,0	12	DK12120B71_FC	5xD	56	71	118
12,0	12	DK12120B114_FC	8xD	90	114	162
12,5	14	DK14125B60_FC	3xD	43	60	107
12,5	14	DK14125B77_FC	5xD	60	77	124
12,5	14	DK14125B133_FC	8xD	125	133	182
13,0	14	DK14130B60_FC	3xD	43	60	107
13,0	14	DK14130B77_FC	5xD	60	77	124
13,0	14	DK14130B133_FC	8xD	125	133	182
13,5	14	DK14135B60_FC	3xD	43	60	107
13,5	14	DK14135B77_FC	5xD	60	77	124
13,5	14	DK14135B133_FC	8xD	125	133	182
14,0	14	DK14140B60_FC	3xD	43	60	107
14,0	14	DK14140B77_FC	5xD	60	77	124
14,0	14	DK14140B133_FC	8xD	125	133	182
14,5	16	DK16145B65_FC	3xD	45	65	115
14,5	16	DK16145B83_FC	5xD	63	83	133
14,5	16	DK16145B152_FC	8xD	138	152	204
15,0	16	DK16150B65_FC	3xD	45	65	115
15,0	16	DK16150B83_FC	5xD	63	83	133
15,0	16	DK16150B152_FC	8xD	138	152	204
15,5	16	DK16155B65_FC	3xD	45	65	115
15,5	16	DK16155B83_FC	5xD	63	83	133
15,5	16	DK16155B152_FC	8xD	138	152	204
16,0	16	DK16160B65_FC	3xD	45	65	115
16,0	16	DK16160B83_FC	5xD	63	83	133
16,0	16	DK16160B152_FC	8xD	138	152	204
16,5	18	DK18165B73_FC	3xD	51	73	123
16,5	18	DK18165B93_FC	5xD	71	93	143
17,0	18	DK18170B73_FC	3xD	51	73	123
17,0	18	DK18170B93_FC	5xD	71	93	143
17,5	18	DK18175B73_FC	3xD	51	73	123

with Internal Coolant, 3xD, 5xD, 8xD

D mm	d mm	Part Number	Type	l mm	l ₂ mm	L mm
17,5	18	DK18175B93_FC	5xD	71	93	143
18,0	18	DK18180B73_FC	3xD	51	73	123
18,0	18	DK18180B93_FC	5xD	71	93	143
18,5	20	DK20185B79_FC	3xD	55	79	131
18,5	20	DK20185B101_FC	5xD	77	101	153
19,0	20	DK20190B79_FC	3xD	55	79	131
19,0	20	DK20190B101_FC	5xD	77	101	153
19,5	20	DK20195B79_FC	3xD	55	79	131
19,5	20	DK20195B101_FC	5xD	77	101	153
20,0	20	DK20200B79_FC	3xD	55	79	131
20,0	20	DK20200B101_FC	5xD	77	101	153



CARBIDE RODS

CONTENTS

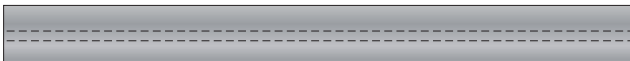
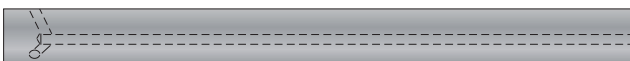

Carbide Rods	124	
Carbide Rods with Internal Coolant	125	
Carbide Rods with Internal Radial Coolant	125	

CARBIDE RODS

Round Blanks

KXF
Micrograin Carbide
0,7 μ , 10% Cobalt
Tolerance
h6, ground and polished

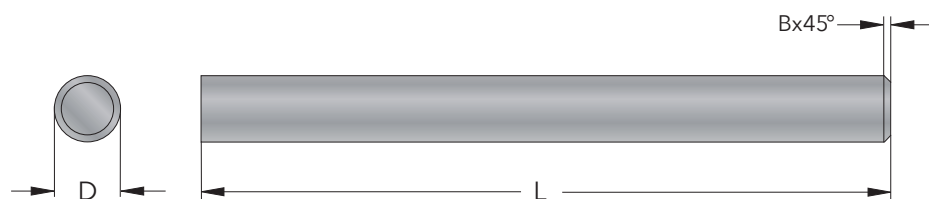

D mm	L mm	B mm	Part Number
3,0	39	0,3	Ø3X39_KXF
3,0	100	0,3	Ø3X100_KXF
3,0	320	0,3	Ø3X320_KXF
4,0	50	0,4	Ø4X50_KXF
4,0	100	0,4	Ø4X100_KXF
4,0	320	0,4	Ø4X320_KXF
5,0	100	0,4	Ø5X100_KXF
5,0	320	0,4	Ø5X320_KXF
6,0	63	0,4	Ø6X63_KXF
6,0	76	0,4	Ø6X76_KXF
6,0	100	0,4	Ø6X100_KXF
6,0	320	0,4	Ø6X320_KXF
8,0	63	0,5	Ø8X63_KXF
8,0	76	0,5	Ø8X76_KXF
8,0	100	0,5	Ø8X100_KXF
8,0	320	0,5	Ø8X320_KXF
10,0	76	0,5	Ø10X76_KXF
10,0	100	0,5	Ø10X100_KXF
10,0	320	0,5	Ø10X320_KXF
12,0	83	0,5	Ø12X83_KXF
12,0	100	0,5	Ø12X100_KXF
12,0	320	0,5	Ø12X320_KXF
14,0	89	0,8	Ø14X89_KXF
14,0	100	0,8	Ø14X100_KXF
14,0	320	0,8	Ø14X320_KXF
16,0	89	0,8	Ø16X89_KXF
16,0	100	0,8	Ø16X100_KXF
16,0	120	0,8	Ø16X120_KXF
16,0	320	0,8	Ø16X320_KXF
18,0	100	0,8	Ø18X100_KXF
18,0	130	0,8	Ø18X130_KXF
18,0	320	0,8	Ø18X320_KXF
20,0	100	1,0	Ø20X100_KXF
20,0	120	1,0	Ø20X120_KXF
20,0	150	1,0	Ø20X150_KXF
20,0	320	1,0	Ø20X320_KXF
25,0	100	1,0	Ø25X100_KXF
25,0	120	1,0	Ø25X120_KXF
25,0	130	1,0	Ø25X130_KXF
25,0	150	1,0	Ø25X150_KXF
25,0	320	1,0	Ø25X320_KXF
32,0	150	1,0	Ø32X150_KXF
32,0	320	1,0	Ø32X320_KXF
40,0	170	1,0	Ø40X170_KXF

CARBIDE RODS

with Internal Coolant

KXF
Micrograin Carbide
0,7 μ , 10% Cobalt
Tolerance
h6, ground and polished

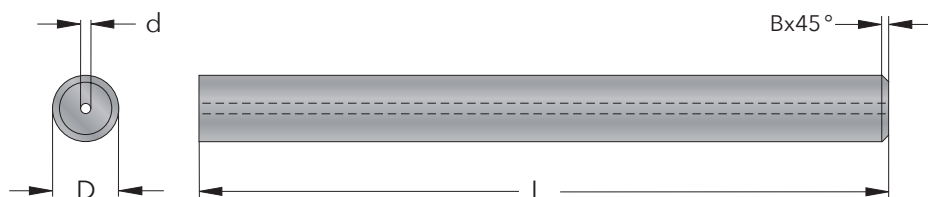

D mm	L mm	d mm	B mm	Part Number
4	50	0,6	0,4	Ø4X50Ø0.6_KXF
6	63	1	0,4	Ø6X63Ø1_KXF
8	76	1,3	0,5	Ø8X76Ø1.3_KXF
10	100	2	0,5	Ø10X100Ø2_KXF
12	100	2	0,5	Ø12X100Ø2_KXF
14	100	2	0,8	Ø14X100Ø2_KXF
16	120	3	0,8	Ø16X120Ø3_KXF
20	150	3	1,0	Ø20X150Ø3_KXF

with Internal Radial Coolant

KXF
Micrograin Carbide
0,7 μ , 10% Cobalt
Tolerance
h6, ground and polished

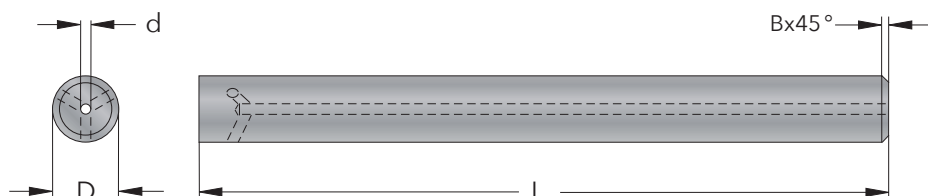

D mm	L mm	d mm	No. of holes	B mm	Part Number
6	76	1	3	0,5	Ø6X76Ø1C_KXF
8	76	1,2	3	1,0	Ø8X76Ø1.2C_KXF
8	76	1,2	4	1,0	Ø8X76Ø1.2D_KXF
10	100	1,2	3	1,0	Ø10X100Ø1.2C_KXF
10	100	1,2	4	1,0	Ø10X100Ø1.2D_KXF
12	100	1,5	4	1,0	Ø12X100Ø1.5D_KXF
12	100	1,5	5	1,0	Ø12X100Ø1.5E_KXF
16	100	1,5	4	1,5	Ø16X100Ø1.5D_KXF
16	100	1,5	5	1,5	Ø16X100Ø1.5E_KXF

■ SmiCut supply rectangular carbide rods

Metric

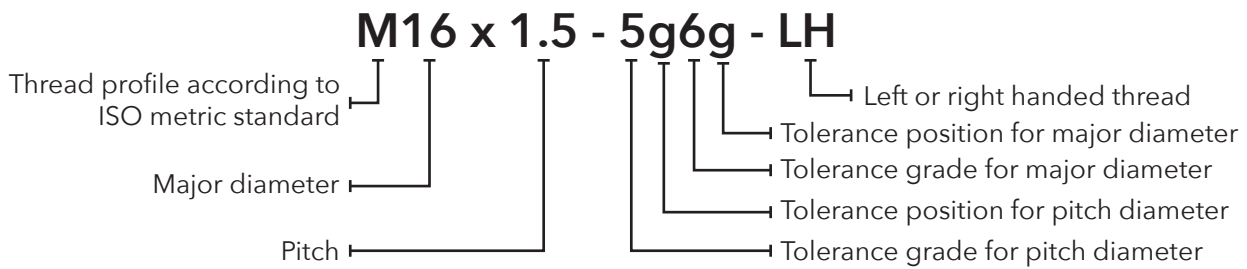

All types and tolerance classes can be produced with ISO metric thread turning and thread milling tools.

For coarse threads, the pitch is not written as it is determined of the diameter, for example M16 instead of M16 x 2.

If the tolerance grade and position is the same for pitch and major diameter, it is written only once, for example 6h instead of 6h6h. Small letter for external threads and capital letter for internal threads. If no tolerance class is written, it means that the tolerance is 6H/6g. Slash between tolerances provide information about the internal and external thread.

It is not necessary to write RH for right hand thread as almost all threads are right handed.

M16 is a simplified writing of M16 x 2 - 6H/6g - RH.

Major diameter mm			Pitch mm
Serie 1	Serie 2	Serie 3	
M1			0,25
	M1,1		0,25
M1,2			0,25
	M1,4		0,3
M1,6			0,35
	M1,8		0,35
M2			0,4
	M2,2		0,45
M2,5			0,45
M3			0,5
	M3,5		0,6
M4			0,7
	M4,5		0,75
M5			0,8
M6			1
		M7	1
M8			1,25
		M9	1,25
M10			1,5
		M11	1,5
M12			1,75
	M14		2
M16			2
	M18		2,5
M20			2,5
	M22		2,5
M24			3
	M27		3
M30			3,5
	M33		3,5
M36			4
	M39		4
M42			4,5
	M45		4,5
M48			5
	M52		5
M56			5,5
	M60		5,5
M64			6
	M68		6

Thread Profile Depth	
external	0,613 x pitch
internal	0,541 x pitch

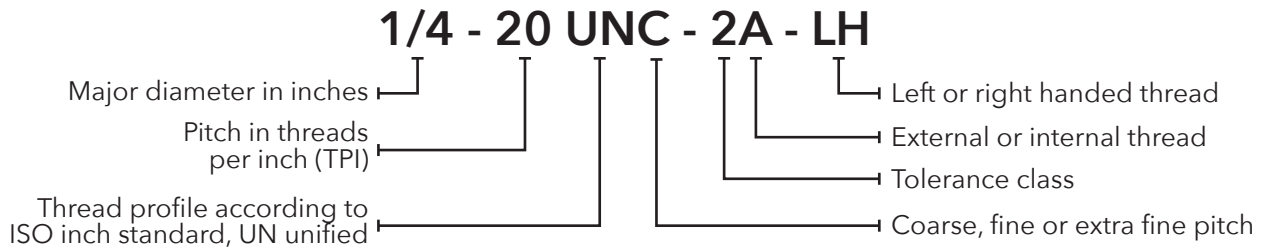

All types and tolerance classes can be produced with UN unified thread turning and thread milling tools.

When the thread is smaller than 1/4", the diameter is given with a number from No. 0 to No. 12 (No. # x 0.013" + 0.060").

Mostly, the pitch is not written as it is determined of the diameter for UNC, UNF and UNEF threads.

If no tolerance class is written, it means that the tolerance is 2A for external threads and 2B for internal.

It is not necessary to write RH for right hand thread as almost all threads are right handed.

1/4 - UNC is a simplified writing of 1/4 - 20 UNC - 2A/2B - RH.

UNC	thread with coarse pitch
UNF	thread with fine pitch
UNEF	thread with extra fine pitch
UN	thread with constant pitch

	external	internal
Loose tolerance	1A	1B
Medium tolerance	2A	2B
Tight tolerance	3A	3B

Thread Profile Depth	
external	15,581 / TPI
internal	13,748 / TPI

Thread	Diameter mm	Pitch TPI		
		UNC	UNF	UNEF
No. 0	1,524	-	80	-
No. 1	1,854	64	72	-
No. 2	2,184	56	64	-
No. 3	2,515	48	56	-
No. 4	2,845	40	48	-
No. 5	3,175	40	44	-
No. 6	3,505	32	40	-
No. 8	4,166	32	36	-
No. 10	4,826	24	32	-
No. 12	5,486	24	28	32
1/4	6,350	20	28	32
5/16	7,937	18	24	32
3/8	9,525	16	24	32
7/16	11,112	14	20	28
1/2	12,700	13	20	28
9/16	14,287	12	18	24
5/8	15,875	11	18	24
3/4	19,050	10	16	20
7/8	22,225	9	14	20
1	25,400	8	12	20
1 1/16	26,988	-	-	18
1 1/8	28,575	7	12	18
1 3/16	30,162	-	-	18
1 1/4	31,750	7	12	18
1 5/16	33,338	-	-	18
1 3/8	34,925	6	12	18
1 7/16	36,512	-	-	18
1 1/2	38,100	6	12	18
1 9/16	39,688	-	-	18
1 5/8	41,275	-	-	18
1 11/16	42,862	-	-	18
1 3/4	44,450	5	-	-
2	50,800	4 1/2	-	-
2 1/4	57,150	4 1/2	-	-
2 1/2	63,500	4	-	-
2 3/4	69,850	4	-	-
3	76,200	4	-	-
3 1/4	82,550	4	-	-
3 1/2	88,900	4	-	-
3 3/4	95,250	4	-	-
4	101,600	4	-	-

THREAD DESIGNATIONS

G/R

British Standard Pipe Thread

G 1/2 A - LH



G - Whitworth / BSPP (P=parallel) Pipe Thread

All types and tolerance classes can be produced with W (Whitworth) thread turning and thread milling tools.

	external	internal
Loose tolerance	A	only one
Tight tolerance	B	class

To get a pressure tight-joint you need a seal ring between the shoulder of the external thread and the face of the internal thread.

R - Whitworth / BSPT (T=tapered) Pipe Thread

All types and tolerance classes of conical threads can be produced with BSPT threading tools.

Rp	Internal cylindrical pipe thread
Rc	Internal conical pipe thread
R	External conical pipe thread

As the thread is conical it will be almost a pressure tight-joint, but to improve the sealing effect you need to use a thread seal tape.

Pitch is not written as it is determined of the diameter.

It is not necessary to write RH for right hand thread as almost all threads are right handed.

Thread Profile Depth	
external	16,256 / TPI
internal	16,256 / TPI

Thread	Pipe diameter	Pitch TPI
1/16	7,723	28
1/8	9,728	28
1/4	13,157	19
3/8	16,662	19
1/2	20,955	14
5/8*	22,911	14
3/4	26,441	14
7/8*	30,201	14
1	33,249	11
1 1/8*	37,897	11
1 1/4	41,910	11
1 1/2	47,803	11
1 3/4*	53,746	11
2	59,614	11
2 1/4*	65,710	11
2 1/2	75,184	11
2 3/4*	81,534	11
3	87,884	11
3 1/2*	100,330	11
4	113,030	11
4 1/2*	125,730	11
5	138,430	11
5 1/2*	151,130	11
6	163,830	11

*This dimension is only for G

Common Thread Profiles

ISO (M) and UN

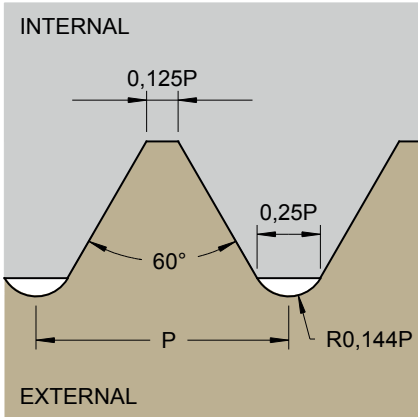

Whitworth (W)

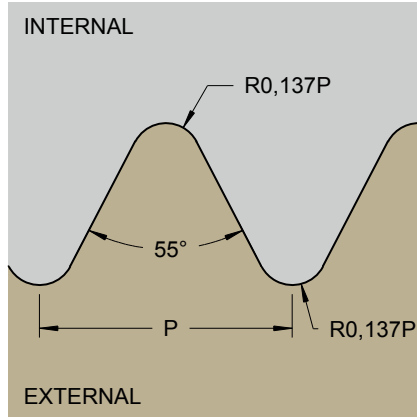

BSPT

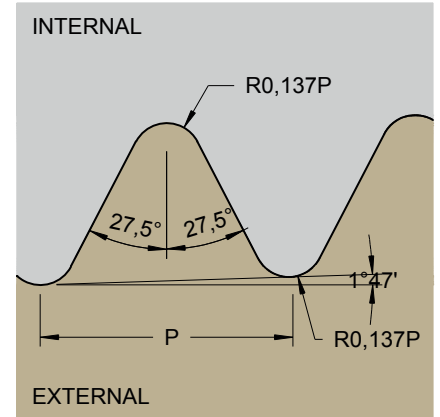

MJ and UNJ

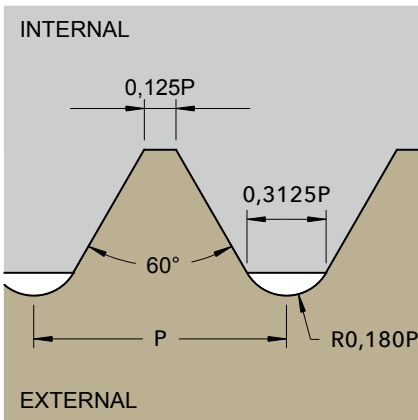

NPT and NPTF

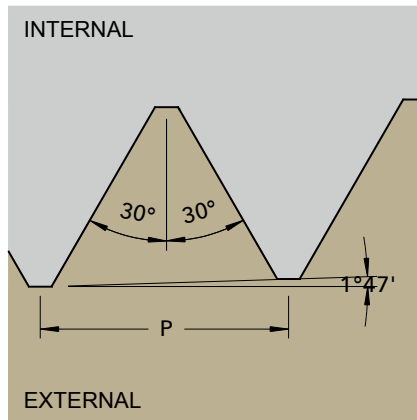

NPSF

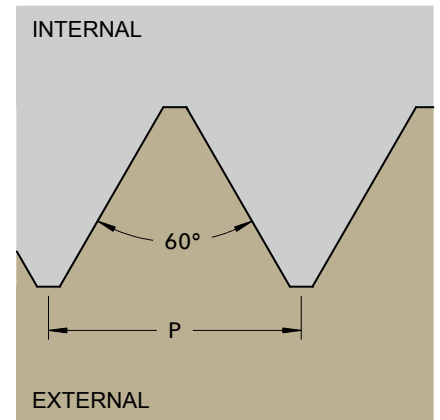

Trapez DIN 103

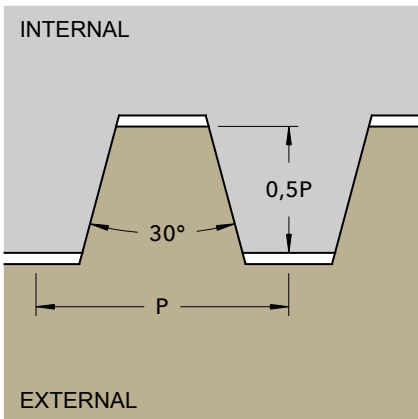

ACME

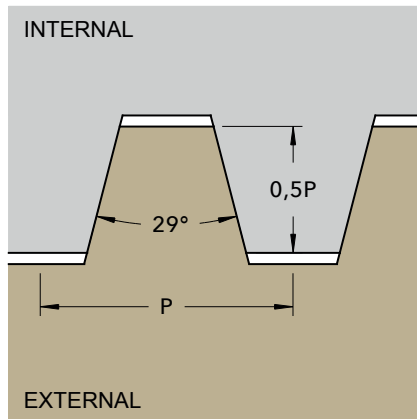

STUB ACME

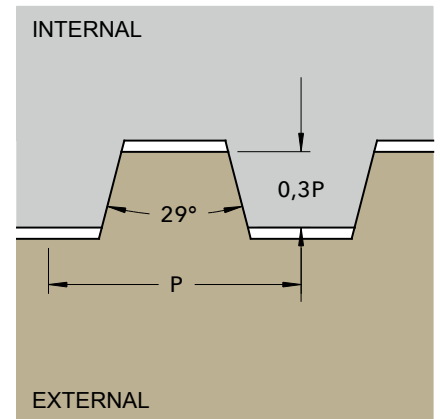

Round DIN 405

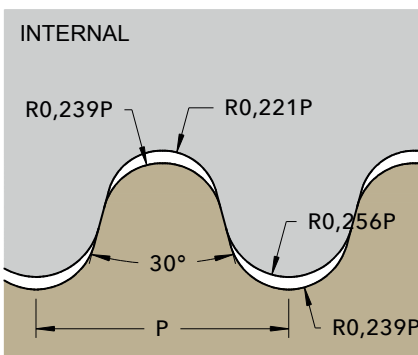

PG DIN 40430

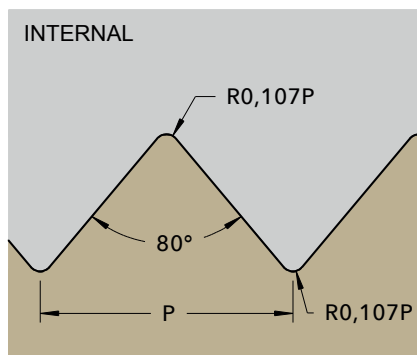

SG DIN 513

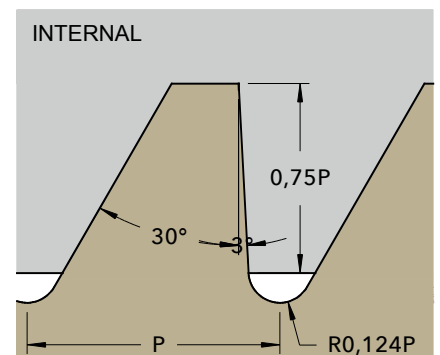



Schmidt Tool Systems - The Master of Threading



SmiCut AB
Fläderstigen 12 - SE-771 43 Ludvika - Sweden
tel. +46 240 182 30 - info@smicut.se - www.smicut.se